

FOX



FREE!



PRODUCT GUIDE

PACKED WITH OUR LATEST AND
GREATEST TACKLE!



HELLO AND WELCOME...

to the 2019 Fox consumer catalogue. Over the past 12 months our product development team have worked tirelessly alongside our consultants from all over Europe to bring you a massive amount of quality new products.

The new offerings vary widely, from products designed to help you put more carp on the bank, to those that will make you more comfortable. Others have been worked on to aid your organisation and attention to detail. Over the coming pages you'll find new additions to most categories, with particular highlights among rods, reels, shelters, clothing, carp care, boats, and tackle and rig storage.

As well as the new products, we do of course, have many items that have been in our range for sometime. Whether new or existing, they share one thing in common: they've been designed and tested by carp anglers to ensure you're investing in products that offer the best value for money.

Talking of money, we've tried to cover as many different people's budgets as possible. We fully appreciate that not all anglers can afford, or indeed justify purchasing, top-end Fox products. This however, doesn't reduce their desire for Fox quality, and with this in mind, our entry-level EOS range has grown substantially for 2019. We've also introduced the R-Series, replacing the previous Royale sub-brand.

With the R-Series, we look to bring you even better quality than the Royale range, and at even better prices!

Enough of our rambling; it's time for the main event... turn the page and enjoy what's in-store for you: the 2019 Fox range!





CONTENTS

	04-13	Bite Indication
	14-19	Rods
	20-25	Reels & Line
	26-41	Shelters
	42-49	Bedchairs, Chairs & Sleeping Bags
	50-77	Luggage & Barrows

	78-83	Boats & Engines
	84-93	Rod Support
	94-101	Carp Care
	102-109	Tackle & Rig Storage
	110-139	Accessories
	140-155	Clothing

CONTACT



foxint.com



/foxInternational



/FoxInternational1



@fox_international



BITE INDICATION

Over the coming pages we'll be showcasing our full range of products associated with bite indication. These include not just our top-selling, multi-award-winning bite alarms, but also an array of indicators, such as our Swingers and bobbins. You'll find bite alarms to suit different budgets, along with our Black Label range of indicators that combine incredible looks with practical functionality.

Last year we launched the RX+ bite alarms. The popularity of these alarms has been nothing short of mind-blowing. As a result, they remain in the range and will do so for many years to come. Such was the popularity and quality of the products showcased in this section of last year's catalogue, the only additions we've made are the incredibly sexy, new Black Label Mini Swingers, which have served to breathe new life into the classic Swinger design.

RX+[®]



MICRON[®] RX+[®]

- Weatherproof sealed case
- Digital circuitry
- D-Tec™ Plus Sensing System (DTSS)
- Low battery drain
- CNC-machined Tru-Run™ roller wheel
- Twin multi-colour LEDs (Red, Green, Blue, Orange, Purple & White)
- On / Off toggle switch with 2 operational modes (day and night)
- When in night mode both LEDs will subtly glow in your chosen colour
- High-quality cone speaker
- Rigid 3/8" stainless steel thread
- Rod-friendly rubber inlays
- Indexed ergonomic control for volume (8 different levels with lowest setting being completely silent)
- Indexed ergonomic control for tone (eight different tone settings: turn dial clockwise to raise pitch and anti-clockwise to lower pitch)
- Indexed ergonomic control for Intelligent Sensitivity featuring see-saw elimination (eight different sensitivity settings – see below sensitivity table for comparison to NTX-R)
- Range test function allows user to check RX+ Receiver is picking up RX+ Head at any given range
- Low battery warning (LED colour changes to cyan indicating it is time to replace batteries)
- Power Out Socket (2.5mm) for use with illuminated Swingers
- Supplied with two compression washer options: rigid and soft with an additional spare soft washer per unit
- Requires 2 x AA batteries



		*RRP
CEI159	Micron RX+	£199.99
CEI156	Micron RX+ 2 Rod Set	£529.99
CEI157	Micron RX+ 3 Rod Set	£649.99
CEI158	Micron RX+ 4 Rod Set	£799.99



Presentation Sets available



MICRON[®] RX+[®] RECEIVER

- Ultra-Long Range™
- Digital circuitry
- Low battery drain
- Battery life indication when receiver is switched on (4 x green LEDs indicates full/close to full, 3 x green LEDs indicate the batteries are used, but do not need replacing, 2 x orange LEDs indicate the batteries are becoming low, 1 x red LED indicates batteries are low and need replacing)
- Low battery warning (LEDs will flash cyan periodically, indicating the batteries need replacing)
- Alarm low battery warning (when RX+ head turns to low battery warning, so will the receiver for that particular alarm, again changing colour to cyan)
- Vibration alert function (via switch on rear)
- Bivvy light function (via switch on rear, see below for more details)
- Anti-theft alarm
- Easy RX+ Micron registration (via switch at rear)
- Indicator LEDs with Colour Sync™
- On/Off & volume control
- High-quality cone speaker
- Lanyard attachment point
- Requires 3 x AA batteries

		*RRP
CEI160	Micron RX+ Receiver	£199.99

BIVVY LIGHT FUNCTION

When the bivvy light feature is turned on via the switch on the back of the receiver, it will behave in the following ways:

- The indication lights on the receiver will be dimmed slightly to prevent the receiver emitting too much light whilst the bivvy light is active
- The bivvy light will only come on if three bite triggers are received in quick succession, to prevent liners and false indication turning your bivvy light on unnecessarily
- The bivvy light will fade into full brightness and remain on whilst the alarm continues to send trigger signals to the receiver. The light will fade out to nothing in the 5 seconds after the trigger lights have gone out on the receiver, as long as no more indications are received



MICRON® MXr+

- Based on original MX+ alarm
- Built-in I-Com Transmitter Technology
- 5mm blue, red, green and orange LEDs available
- Two-stage sensitivity
- Tru-Run roller wheel for super slick bite detection
- Cone speaker for enhanced sound quality
- Indexed tone adjustment knob
- Indexed volume adjustment knob
- Power out socket (for use with illuminated Swingers)
- Rubber ear inlays
- D-Tec Sensing System (DTSS) eliminates the need for the reed switches used in other alarms, making it much more durable
- Powered by 2 x AAA batteries
- Low battery drain
- Hard cases supplied
- All blue presentation sets available in 2-rod, 3-rod and 4-rod
- Red, orange and green 3-rod presentation set available
- Red, orange, green and blue 4-rod presentation set available

*RRP

CEI141	Micron MXr+ 2-Rod Presentation Set	£299.99
CEI142	Micron MXr+ 3-Rod Presentation Set	£399.99
CEI143	Micron MXr+ 4-Rod Presentation Set	£475.00
CEI153	Micron MXr+ 3 Rod Multi Colour Set	£399.99
CEI154	Micron MXr+ 4 Rod Multi Colour Set	£499.99

MICRON® Mr+

- Based on original M+ alarm
- Built-in I-Com Transmitter Technology
- 5mm red LED
- Indexed volume adjustment knob
- Tru-Run roller wheel for super slick bite detection
- Power out socket (for use with illuminated Swingers)
- Piezo speaker for clear sound
- Rubber ear inlays
- Micro Transmitter
- D-Tec Sensing System (DTSS) eliminates the need for the reed switches used in other alarms making it much more durable
- Powered by 2 x AAA batteries
- Low battery drain
- Hard cases supplied
- Available in 2-rod, 3-rod and 4-rod presentation sets
- Single heads also available separately

*RRP

CEI137	Micron Mr+ 2-Rod Presentation Set	£199.99
CEI138	Micron Mr+ 3-Rod Presentation Set	£249.99
CEI139	Micron Mr+ 4-Rod Presentation Set	£325.00
CEI140	Micron Mr+ Single Head	£74.99

FEATURES



Both models feature a Tru-Run roller wheel for slick bite detection



Cone speaker on MXr+ for enhanced sound quality



Both models come supplied with a hard case for protection in transit



Presentation Sets available



MICRON® MX+

- 5mm blue LED
- Two-stage sensitivity
- Cone speaker for enhanced sound quality
- Indexed tone adjustment knob
- Indexed volume adjustment knob
- 1 x power out socket (for use with illuminated Swingers)
- 1 x transmitter out socket
- Rubber ear inlays
- D-Tec Sensing System (DTSS) eliminates the need for the reed switches used in other alarms making it much more durable
- Powered by 2 x AAA batteries
- Long battery life
- Free hard case supplied

MICRON® M+

- 5mm red LED
- Indexed volume adjustment knob
- 1 x power out socket
- 1 x transmitter out socket
- Piezo speaker for clear sound
- Rubber ear inlays
- Micro transmitter
- D-Tec Sensing System (DTSS) eliminates the need for the reed switches used in other alarms making it much more durable
- Powered by 2 x AAA batteries
- Free hard case supplied

FEATURES



Our sensors guarantee instant bite detection and rubber inlays in the 'ears' eliminate rod slippage



Two accessory outputs: one a power out for use with illuminated indicators, the other a transmitter output for use with the TX-R Micro



Classic Micron styling with an easy-to-use front toggle on/off switch and hi-visibility raised 5mm LEDs

CEI120 Micron MX+ *RRP £49.99

CEI119 Micron M+ *RRP £34.99

ALARM COMPARISON CHART	MICRON® RXr+®	MICRON® MXr+	MICRON® Mr+	MICRON® MX+	MICRON® M+
Built in Radio	✓	✓	✓	-	✓
Volume Control	✓	✓	✓	✓	✓
Tone Control	✓	✓	-	✓	-
Intelligent™ Sensitivity (number of positions)	✓	✓ 2	-	✓ 2	-
D-Tec™ Sensing System (DTSS)	✓	✓	✓	✓	✓
LED Colours (M=Multi-colour, B=Blue, R=Red)	M	M	R	B	R
Night Mode	✓	-	-	-	-
Drop Back Differentiation	✓	-	-	-	-
Power Out Socket	✓	✓	✓	✓	✓
Extension Box Socket	-	-	-	✓	✓
Low Level Battery Warning	✓	✓	✓	✓	-
Battery	2x AA	2x AAA	2x AAA	2x AAA	2x AAA
Receiver/Transmitter Rating	■■■	■■■	■■■	■■■	■■■
Cone Speaker	✓	✓	-	✓	-
Piezo Speaker	-	-	✓	-	✓
Easy Micron Registration	✓	-	-	-	-
Colour Sync	✓	-	-	-	-
Anti-Theft Alarm	✓	-	-	-	-
*RRP	£199.99	£94.99	£74.99	£49.99	£34.99



Black Label bite indicators were designed to complement our market-leading Black Label bankware range and really do combine style with functionality.

One of the main benefits of the Black Label range is that you can purchase a set of bobbins for a relatively low price and then customise them to suit the angling situation you are faced with by utilising our Custom Indicator System (C.I.S).

NEW



MINI SWINGER

- Based on the design of the iconic Fox Swinger MK3 but with a shorter arm (45mm less) and reduced head size (40% smaller)
- Also features a Black Label hockey stick thread attachment instead of traditional Swinger Plate making for less bulk and quick interchange with different Black Label indicators
- 16 gram sliding weight on arm
- Matt black anodised coating on arm and weight
- Fixed line gate system
- Rubber shock absorbers on bottom of the head
- Opaque finish on head
- Head features isotope slot (for use with the Black Label Micro Isotope)
- Great all-round indicator for fishing with slack, semi-slack and tight lines
- Especially good for eliminating false indications in windy conditions
- Available in 7 colours: Red, Orange, Green, Blue, Black, Purple and White

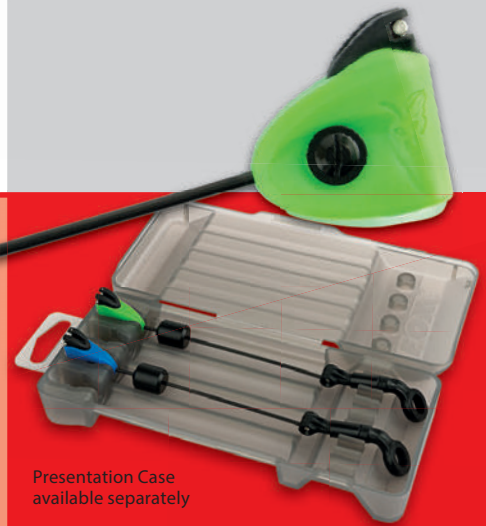

Presentation Case available separately

		*RRP
CSI068	Mini Swinger Red	£17.99
CSI069	Mini Swinger Orange	£17.99
CSI070	Mini Swinger Green	£17.99
CSI071	Mini Swinger Blue	£17.99
CSI072	Mini Swinger Black	£17.99
CSI073	Mini Swinger Purple	£17.99
CSI074	Mini Swinger White	£17.99
CSI075	Mini Swinger Presentation Case	£14.99

DUMPY BOBBIN

- Classic old school look
- Injection moulded opaque coloured main body with two transparent isotope windows
- Isotope windows allow you view glow from the sides or from the front
- Unique indented cap is removable allowing the isotopes to be inserted and also allows the you to perfectly align the line clip and isotope windows
- Weighs 13g
- Supplied with brass weight insert that can be added to the body to bring total weight to 20g
- Available in Red, Orange, Green, Blue, Purple, White and Black
- 6ins black anodised ball chain
- Machined black aluminium hockey stick connection
- Ideal for medium to long range



		*RRP
CBI097	Dumpy Bobbin Red	£14.99
CBI098	Dumpy Bobbin Orange	£14.99
CBI099	Dumpy Bobbin Green	£14.99
CBI100	Dumpy Bobbin Blue	£14.99
CBI101	Dumpy Bobbin Purple	£14.99
CBI102	Dumpy Bobbin White	£14.99
CBI103	Dumpy Bobbin Black	£14.99



STEALTH BOBBIN

- Machined aluminium body
- Memory-free 6ins super soft black Dacron cord with machined black aluminium hockey stick connection
- Cord can be shortened if necessary
- Narrow mid-section with isotope viewing slots allows glow from isotope to be seen from all angles
- Ideal for slack line fishing at short range and semi-slack line fishing at medium range
- Features unique Black Label Slik Bobbin Clip, which can fix to line for greater sensitivity, but can also be left free running should you wish
- Line tension can be adjusted by tightening or loosening clip on the body
- Weighs 5g
- Colours can be changed at any time by purchasing individual Slik Bobbin Clips and removing the black collar they are supplied with



		*RRP
CBI088	Stealth Bobbin Red	£12.99
CBI089	Stealth Bobbin Orange	£12.99
CBI090	Stealth Bobbin Green	£12.99
CBI091	Stealth Bobbin Blue	£12.99
CBI092	Stealth Bobbin Purple	£12.99
CBI093	Stealth Bobbin White	£12.99
CBI094	Stealth Bobbin Black	£12.99





SLIK® BOBBIN CLIPS

- Can be used to convert a standard Black Label Bobbin into a Slik Bobbin for greater sensitivity
- Adjustable collar to change tightness of clip for differing line diameters
- Also enables you to customise your Slik Bobbins with different colour heads
- Available in Green, Red, White, Blue, Black, Purple and Orange

		*RRP
CBI058	Black Label Bobbin Clip White	£3.99
CBI059	Black Label Bobbin Clip Blue	£3.99
CBI060	Black Label Bobbin Clip Red	£3.99
CBI061	Black Label Bobbin Clip Purple	£3.99
CBI062	Black Label Bobbin Clip Green	£3.99
CBI063	Black Label Bobbin Clip Black	£3.99
CBI084	Black Label Bobbin Clip Orange	£3.99



MICRO HEAD

- Very sexy, miniature bobbin head
- Measure just 16mm long
- Perfect for fishing slack lines at short range
- Allows you to convert standard and Slik Bobbins into much smaller, lighter bobbin in seconds
- Available in Green, Red, White, Blue, Gunsmoke, Purple and Orange

		*RRP
CBI046	Black Label Micro Head White	£3.99
CBI047	Black Label Micro Head Blue	£3.99
CBI048	Black Label Micro Head Red	£3.99
CBI049	Black Label Micro Head Purple	£3.99
CBI050	Black Label Micro Head Green	£3.99
CBI051	Black Label Micro Head Gunsmoke	£3.99
CBI082	Black Label Micro Head Orange	£3.99



COLOURED BALL CLIPS

- Opaque ball clips available in seven colours: Red, Orange, Green, Blue, Purple, White and Black
- Adjustable tension collar
- Allows you to match your bobbin clip to the bobbin body and the bite alarm LED
- Can be used with all Black Label Bobbins (except the Stealth models)

		*RRP
CBI111	Coloured Ball Clip Red	£4.49
CBI112	Coloured Ball Clip Orange	£4.49
CBI113	Coloured Ball Clip Green	£4.49
CBI114	Coloured Ball Clip Blue	£4.49
CBI115	Coloured Ball Clip Purple	£4.49
CBI116	Coloured Ball Clip White	£4.49
CBI117	Coloured Ball Clip Black	£4.49



COLOURED PIVOTING BALL CLIPS

- Opaque pivoting clips available in seven colours: Red, Orange, Green, Blue, Purple, White and Black
- Allows you to match your bobbin clip to the bobbin body and the bite alarm LED
- Can be used with all Black Label Bobbins (except the Stealth models)

		*RRP
CBI104	Pivoting Ball Clip Red	£5.99
CBI105	Pivoting Ball Clip Orange	£5.99
CBI106	Pivoting Ball Clip Green	£5.99
CBI107	Pivoting Ball Clip Blue	£5.99
CBI108	Pivoting Ball Clip Purple	£5.99
CBI109	Pivoting Ball Clip White	£5.99
CBI110	Pivoting Ball Clip Black	£5.99





STEALTH CORD

- Memory-free 6ins super soft and lightweight black Dacron cord
- Can be cut down to a shorter length should you require
- Perfect for slack line fishing at short range and semi-slack fishing at medium range

		*RRP
CBI096	6" Stealth Cord	£4.99



CHAIN LINK

- 6ins black anodised link chain
- Complements Black Label bankware range
- Ideal for short to medium range fishing

		*RRP
CBI095	6" Chain Link	£4.99



MINI SWINGER ARM

- Based on traditional Swinger design
- Pivot points at both ends for extra sensitivity
- Black, anodised finish
- Ideal for windy conditions
- Complements Black Label bankware range

		*RRP
CBI066	Black Label Mini Swinger Arm	£6.99



TITANIUM QUIVER ARMS

- Titanium wire quivers for ultimate bite indication
- Compatible with all Slim Black Label heads
- Recommended for use with Micro Heads with either a Pivoting Ball Clip or standard Coloured Ball Clip
- 3 diameters available to suit the range you fish at: Super Soft for short/medium range, Medium for medium/long range and Stiff for long/extreme range
- Super Soft enables you to fish with semi-slack lines
- Can be used in conjunction with the Black Label Adjustable Hockey Stick to create the optimum tension for most fishing situations

		*RRP
CBI085	Titanium Quivers Soft	£5.99
CBI086	Titanium Quivers Medium	£5.99
CBI087	Titanium Quivers Stiff	£5.99



ISOTOPES

- Enables your indicator head to have a subtle glow in the dark/low light
- Available in three sizes: 3mm x 25mm, 2mm x 12mm and the new 2mm x 15mm, which is designed to fit the Black Label Mini Swinger
- Only available in United Kingdom

		*RRP
CLI006	Isotope 3x25mm	£13.99
CLI007	Isotope 2x12mm	£7.99
CLI008	Isotope 2x15mm	NEW £10.99



HOCKEY STICK

- Constructed from hard-wearing injection moulded black plastic
- Can be used with Black Label Springer Arm, Swinger Arm, Dacron Cord, Ball Chain or Link Chain
- Easy to use screw thread

		*RRP
CBI072	Black Label Hockey Stick x1	£3.99



ADJUSTABLE HOCKEY STICKS

- Injection moulded hard-wearing black plastic
- Adjustable stick allows you to set the tension you require from your bite indicator – simply screw your chosen cord, chain or quiver arm into place to lock the hockey stick in position

		*RRP
CBI118	Adjustable Hockey Stick	£4.99



ADJUSTABLE ROD CLIPS

- Designed for fishing bow-string tight lines with quiver style indicators
- Adjustable tensioning dial to accommodate low diameter monofilament and braid
- Can also be used with light bobbins when fishing slacker lines for increased bite indication
- One size to fit all rods (ensure rod blank is clean before attaching)
- Increases the angle in the line for improved visual indication
- Interchangeable black ball clips (allows you to customise with new coloured Black Label Ball Clips should you wish)

		*RRP
CBI124	Adjustable Rod Clips x2	£7.99



SLIM WEIGHTS

- Allows you to increase weight of slim heads supplied on Bobbin and Slik Bobbin
- Weigh 5g each
- Two weights supplied per packet
- 'Hardwearing', black anodised finish
- Complements Black Label bankware range

		*RRP
CBI064	Slim Weights 5g x2	£3.99

POWER GRIP LINE CLIPS

- CAD-designed line clips that hold line securely without causing any damage
- Line sits in small recess behind arm of clip so it is not damaged
- Rubber inlay prevents clip from damaging rod blank
- Available in two colours: White and Orange
- Available in two sizes: Small and Large
- Three clips per packet



		*RRP
CAC594	Line Clips Small x3 White	£8.99
CAC595	Line Clips Small x3 Orange	£8.99
CAC596	Line Clips Large x3 White	£8.99

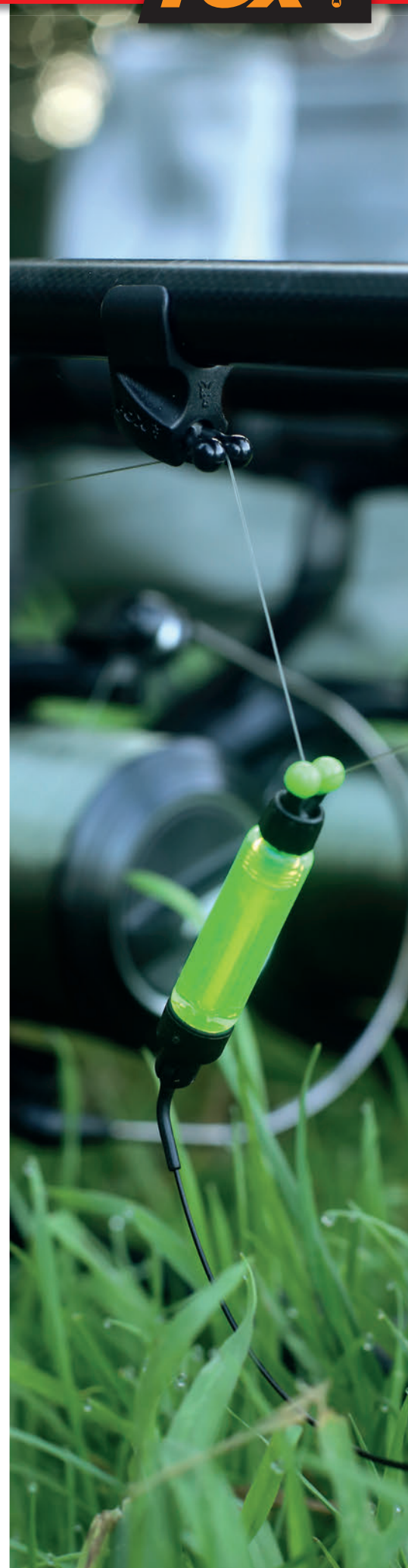



MK2 ILLUMINATED SWINGER

- Matt black anodised coating on arm and weight
- Illuminates when connected to bite alarm with power out facility
- Head display mimics Micron LED to signal drop back indication
- Streamlined Micron attachment tabs
- Rubber shock absorbers on bottom of head
- Widened front end for increased visibility
- Spring-loaded adjustable tensioning system
- Fixed line gate system
- 80g sliding collar weight
- Light-reactive acrylic indicator head
- Betalight Slot
- Available in Red, Orange, Green, Blue, Black and new Purple colour options
- 3-Rod presentation set available (Red, Orange and Green)
- 4-Rod presentation set available (Red, Orange, Green and Blue)
- Swinger Case also available separately

		*RRP
CSI049	MK2 Illuminated Swinger Red	£42.99
CSI050	MK2 Illuminated Swinger Orange	£42.99
CSI051	MK2 Illuminated Swinger Green	£42.99
CSI052	MK2 Illuminated Swinger Blue	£42.99
CSI053	MK2 Illuminated Swinger Black	£42.99
CSI063	MK2 Illuminated Swinger Purple	£42.99
CSI054	MK2 Illuminated Swinger 3-Rod Set	£144.99
CSI055	MK2 Illuminated Swinger 4-Rod Set	£189.99
CSI058	MK2 Illuminated Swinger Case	£17.99



Available in 3-rod and 4-rod presentation sets

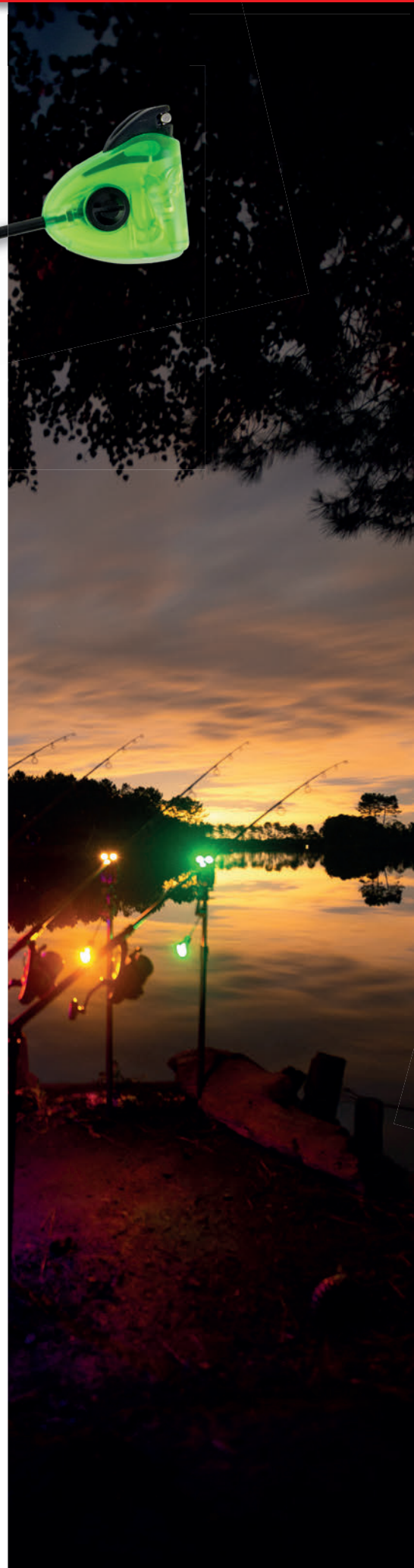

Available in 3-rod and 4-rod presentation sets



MK3 SWINGER

- Matt black anodised coating on arm and weight
- Streamlined Micron attachment tabs
- Fixed-line gate system
- Rubber shock absorbers on bottom of head
- Widened front end for increased visibility
- Light reactive acrylic indicator head
- Betalight slot
- 50g Sliding weight allows tension on line to be adjusted
- Available in Red, Orange, Green, Blue, Black and new Purple colour options
- 3-Rod presentation set available (Red, Orange and Green)
- 4-Rod presentation set available (Red, Orange, Green and Blue)
- Swinger Case also available separately

		*RRP
CSI042	MK3 Swinger Red	£29.99
CSI043	MK3 Swinger Orange	£29.99
CSI044	MK3 Swinger Green	£29.99
CSI045	MK3 Swinger Blue	£29.99
CSI046	MK3 Swinger Black	£29.99
CSI062	MK3 Swinger Purple	£29.99
CSI047	MK3 Swinger 3-Rod Set (R,O,G)	£99.99
CSI048	MK3 Swinger 4-Rod Set (R,O,G,B)	£124.99
CSI057	MK3 Swinger Case	£17.99



Available in 3-rod and 4-rod presentation sets



MICRO SWINGER

- Matt black anodised coating on arm and weight
- Compact stainless steel arm for greater sensitivity at short and medium range
- Adjustable line clip system
- Low-friction gate on head
- 42g sliding collar weight
- Light-reactive acrylic indicator head
- Betalight slot
- Available in Red, Orange, Green, Blue, Black and new Purple colour options
- 3-Rod presentation set available (Red, Orange and Green)
- 4-Rod presentation set available (Red, Orange, Green and Blue)
- Swinger Case also available separately

		*RRP
CSI035	Micro Swinger Red	£15.99
CSI036	Micro Swinger Orange	£15.99
CSI037	Micro Swinger Green	£15.99
CSI038	Micro Swinger Blue	£15.99
CSI039	Micro Swinger Black	£15.99
CSI061	Micro Swinger Purple	£15.99
CSI040	Micro Swinger 3-Rod Set (R,O,G)	£54.99
CSI041	Micro Swinger 4-Rod Set (R,O,G,B)	£69.99





RODS

What a year it's been for our rods! Over the past 12 months our top-end Horizon X5 range has firmly established itself, not only as the best carp fishing rod we've ever produced, but also as one of the best marketed by any manufacturer! Used by many of the world's best long-distance casters, the Horizon X5 range has built itself a formidable reputation as the go-to rod for anglers who want the very best, without paying prices commanded by custom rod makers. At the other end of the price spectrum is our EOS rod range: a market leader in the entry-level category.

For 2019 we've made a few tweaks to the rods that you'll find between the price points of the X5 and EOS ranges. We've discontinued our Horizon X, Torque and Warrior S models and replaced them with two new ranges in the form of the Horizon X4 and Horizon X3. Both offer incredible value for money and you're sure to be impressed with what you see on the coming pages...



HORIZON® X5

- Ultra-high modulus carbon blank featuring multi-directional Nanofibre and Interlaminar resin
- Blank also features 1k carbon wrap
- Fast recovery to aid distance and accuracy when making the longest of casts
- Superb playing action
- Reinforced carbon power joints for added strength at spigot
- Fuji K-Series Guides throughout - 50mm butt to 16mm tip – these dramatically help to prevent tangles on the cast
- Fuji 18mm DPS reel seat
- Black fittings and whippings
- Understated cosmetics
- New Slim Cork models now available in 12ft 3.25lb, 12ft 3.75lb and 13ft 3.75lb

		*RRP
CRD259	Horizon X5 12ft 3.25lb Abbreviated	£299.99
CRD261	Horizon X5 12ft 6in 3.5lb Abbreviated	£309.99
CRD263	Horizon X5 12ft 3.75lb Abbreviated	£309.99
CRD265	Horizon X5 13ft 3.75lb Abbreviated	£329.99
CRD260	Horizon X5 12ft 3.25lb Full Slim Duplon	£309.99
CRD262	Horizon X5 12ft 6in 3.5lb Full Slim Duplon	£319.99
CRD264	Horizon X5 12ft 3.75lb Full Slim Duplon	£319.99
CRD266	Horizon X5 13ft 3.75lb Full Slim Duplon	£339.99
CRD271	Horizon X5 12ft 3.25lb Slim Cork	NEW £319.99
CRD272	Horizon X5 12ft 3.75lb Slim Cork	NEW £329.99
CRD273	Horizon X5 13ft 3.75lb Slim Cork	NEW £349.99

FEATURES



Laser-etched Fox head logo in butt cap on all rods in the Horizon X5 range



Fuji K-Series guides throughout - 50mm butt ring through to 16mm tip



New Slim Cork models now available



All rods feature a 50mm K-Series butt ring that reduces tangles on the cast



All models benefit from market-leading Fuji 18mm DPS reel seats

HORIZON® X5 SPOD/MARKER

- Styled to match the Horizon X5 fishing rods
- 5.5lb test curve
- Multi-purpose rod for both feature finding and baiting up with heavy spods
- Fuji K-Series Guides throughout - 50mm butt to 16mm tip – these dramatically help to prevent tangles from occurring on the cast
- Benefits from many of the same features as the fishing rods
- 12ft and 13ft options available

		*RRP
CRD267	X5 12ft Spod/Marker Japanese Shrink Wrap	£249.99
CRD268	X5 13ft Spod/Marker Japanese Shrink Wrap	£259.99



NEW



HORIZON® X4

- The new Horizon X4 rods benefit from a high-modulus, multi-directional carbon construction with a full 2K weave wrap, resulting in a lightweight, crisp action
- Anti-tangle guides
- Fuji 18mm DPS reel seat
- Gloss Finish
- Understated cosmetics
- 40mm butt ring on all 10ft models plus both 12ft 2.75lb models (50mm butt ring on all other models)
- Abbreviated and slim cork handle options available

		*RRP
CRD274	Horizon X4 12ft 2.75lb Abbreviated	£159.99
CRD276	Horizon X4 12ft 3.00lb Abbreviated - 50mm Butt Ring	£169.99
CRD278	Horizon X4 12ft 3.50lb Abbreviated - 50mm Butt Ring	£179.99
CRD280	Horizon X4 13ft 3.50lb Abbreviated - 50mm Butt Ring	£199.99
CRD281	Horizon X4 10ft 3.20lb Abbreviated	£149.99
CRD282	Horizon X4 10ft 3.50lb Abbreviated	£159.99
CRD275	Horizon X4 12ft 2.75lb Cork	£169.99
CRD277	Horizon X4 12ft 3.00lb Cork - 50mm Butt Ring	£179.99
CRD279	Horizon X4 12ft 3.50lb Cork - 50mm Butt Ring	£189.99

HORIZON® X4 SPOD/MARKER

- Perfect for both baiting up and feature finding
- Styled to match the Horizon X4 fishing rods
- 5.5lb test curve
- 50mm butt ring to 16mm tip
- Anti-tangle guides
- Fuji 18mm DPS reel seat
- Gloss Finish
- 12ft and 13ft options available

		*RRP
CRD283	X4 12ft Spod/Marker Japanese Shrink Wrap - 50mm Butt Ring	£159.99
CRD284	X4 13ft Spod/Marker Japanese Shrink Wrap - 50mm Butt Ring	£169.99



FEATURES



Fuji 18mm DPS reel seat on all models



Anti-tangle guides throughout



Abbreviated/cork options to pick from



'Old school' gloss finish



NEW



HORIZON® X3

- The new Horizon X3 rods offer unbelievable value for money and are ideal for anglers on tight budgets that still want unrivalled Fox quality
- High-modulus, lightweight carbon blank construction that provides superb all round performance
- Multi-directional carbon construction
- Anti-tangle guides
- 18mm DPS-style reel seat
- Black fittings and whippings
- Understated graphics
- 40mm butt ring on all 10ft models plus both 12ft 2.75lb models, as well as a 12ft 3lb Abbreviated option - 50mm butt ring on all other models including a 12ft 3lb abbreviated option
- Abbreviated and slim cork handle options available

		*RRP
CRD285	Horizon X3 10ft 3.00lb Abbreviated	£79.99
CRD286	Horizon X3 10ft 3.50lb Abbreviated	£79.99
CRD287	Horizon X3 12ft 2.75lb Abbreviated	£84.99
CRD289	Horizon X3 12ft 3.00lb Abbreviated	£84.99
CRD297	Horizon X3 12ft 3.00lb Abbreviated - 50mm Butt Ring	£89.99
CRD291	Horizon X3 12ft 3.50lb Abbreviated - 50mm Butt Ring	£94.99
CRD293	Horizon X3 13ft 3.50lb Abbreviated - 50mm Butt Ring	£94.99
CRD288	Horizon X3 12ft 2.75lb Cork	£94.99
CRD290	Horizon X3 12ft 3.00lb Cork	£94.99
CRD292	Horizon X3 12ft 3.50lb Cork	£104.99

HORIZON® X3 SPOD/MARKER

- Perfect for both baiting up and feature finding
- Styled to match the Horizon X3 fishing rods
- 5.5lb test curve
- 50mm butt ring to 16mm tip
- Anti-tangle guides
- 18mm DPS-style reel seat
- 12ft and 13ft options available

		*RRP
CRD294	Horizon X3 12ft 5.50lb Abbreviated - 50mm Butt Ring	£94.99
CRD295	Horizon X3 13ft 5.50lb Abbreviated - 50mm Butt Ring	£99.99



FEATURES



18mm DPS-style reel seat



Anti-tangle guides throughout



Cork handle versions also available



50mm butt ring on selected models



EOS®

- Designed to offer incredible value for money
- Five models available including new 10ft 3lb and 12ft 3lb 3-Piece
- Perfect newcomers, juniors or anglers on a very tight budget that still want Fox quality
- Lightweight low-resin, high-quality carbon construction
- Understated matt black finish
- Ergonomic tapered butt grip
- 18mm DPS-style reel seats hold reels of all sizes securely
- Tried and trusted Fox SLIK guide system
- 10ft and 12ft 3lb is perfect for smaller venues and use with bait and rowing boats
- 12ft 3lb 3-Piece is ideal for small vehicles and traveling light (comprises 3 x 4ft/122cm sections)
- 13ft 3.5lb ideal for larger venues where longer casts may be needed – also ideal for PVA bag and Method feeder fishing
- 12ft 3lb Telescopic model also available, which retracts to 4ft (122cm) for compact storage when in transit
- All models except 13ft feature 40mm butt ring through to 14mm tip ring
- 13ft 3.5lb features a larger 50mm butt ring through to 16mm tip ring to aid casting performance

FEATURES



18mm DPS-style reel seat



Top-quality carbon blank



Telescopic model also available



SLIK guide system throughout

		*RRP
CRD258	EOS 10ft 3lb Abbreviated	£39.99
CRD254	EOS 12ft 3lb Abbreviated	£44.99
CRD255	EOS 13ft 3.5lb Abbreviated - 50mm Butt Ring	£54.99
CRD257	EOS 12ft 3lb Abbreviated - 3 pc	£44.99
CRD256	EOS 12ft 3lb Telescopic Abbreviated	£44.99

NEW

EOS® SPOD & MARKER

- Designed to complement EOS rod range
- Dual-purpose for use both as a spod and marker rod
- 5lb test curve
- Lightweight low-resin carbon construction
- Fox SLIK guide system throughout
- High-quality 18mm reel seat
- Understated cosmetics with matt black finish
- Ergonomic tapered butt grip
- Offers unrivalled value for money

		*RRP
CRD296	EOS 12ft 5lb Spod & Marker	£49.99

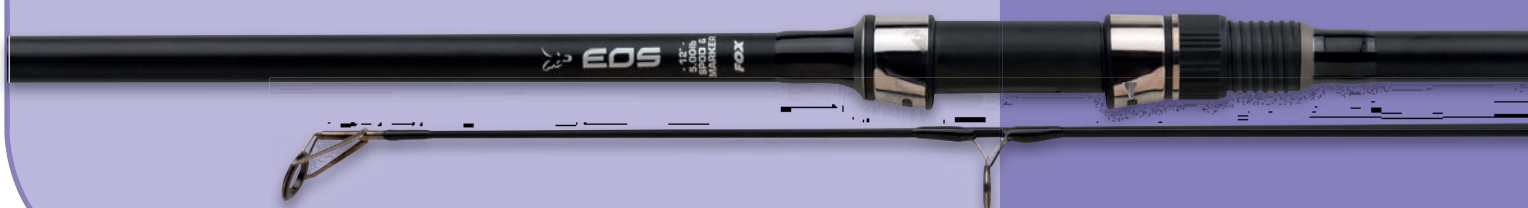



REELS & LINE

Why should you buy Fox reels? Well, the simple answer is because unlike the vast majority, Fox reels are actually designed specifically for the purpose of carp fishing. What's more, they're designed and tested by carp anglers. Most reels sold for carp fishing are not purpose-designed, but are intended instead, for sea angling and have a few cosmetic tweaks in order that they can be passed off as carp models. Here at Fox, we're extremely passionate about reel development, with the simple brief that we make reels that do the job they're intended for, whilst still offering incredible value for money.

We currently offer two reel ranges: the FX range comprising three models (FX9, FX11 and FX13) and the lower-priced EOS range, which now includes a brand new model in the shape of the 10000FD - a front drag version of our record-selling EOS 10000 which features a rear freespool facility.

In addition to producing reliable, purpose-built carp fishing reels, we also offer an extensive range of lines to spool them up with. Whether you're in the market for monofilament, fluorocarbon or braid, you're sure to find the perfect product in the coming pages. As well as the mainlines, we also make a range of leaders that offer the ultimate protection when snag fishing or long-range casting.

FX13

- Bigger brother to our top-selling FX11
- Huge line capacity that is ideal for distance casting and long-range boat fishing
- Machined solid aluminium handle
- Stainless steel shaft
- 90cm of line retrieved per handle turn
- Super-slow oscillation for immaculate line lay
- Carbon reinforced polymer body and rotor
- Quick clutch with grit guard
- Minimalist matt black styling and discreet silver trims
- Rotor brake
- Anti-backlash system
- Micro line lay adjustment
- Rotor line guard
- 2 range casting line clips – one black, one silver
- Rotor Balanced Profile
- Twist-free roller
- Pro-cast lip on spool
- 5 stainless steel ball bearings + 1 roller bearing
- Gear ratio: 4.3:1
- Weight: 761g

		*RRP
CRL071	FX13 Reel	£139.99
CRL072	FX13 - Standard Spare Spool	£29.99
CRL073	FX13 - Spare Shallow Spool	£29.99

0.33mm/750m 0.37mm/570m
0.35mm/650m 0.40mm/500m

FX11

- Machined solid aluminium handle
- Improved gearing
- Super-slow oscillation for immaculate line lay
- 95cm of line retrieved per handle turn
- Quick Clutch with grit guard
- Hard-wearing, graphite body, with minimalist matt black styling and discreet silver trims
- Rotor brake
- Anti-backlash system
- Micro line lay adjustment
- Rotor line guard
- 2 range casting line clips – one black, one silver
- Rotor Balanced Profile
- Twist free roller
- Pro-cast lip on spool
- 5 stainless steel ball bearings + 1 roller bearing
- Gear ratio: 4.6:1
- Weight: 590g

		*RRP
CRL070	FX11 Reel	£119.99
CRL058	FX11 - Spare Spool	£29.99
CRL061	FX11 - Spare Shallow Spool	£29.99

0.30mm/590m 0.35mm/435m
0.33mm/490m 0.37mm/390m

FX9

- Machined solid aluminium handle
- Improved gearing
- Super-slow oscillation for immaculate line lay
- 80cm of line retrieved per handle turn
- Quick clutch with grit guard
- Hard-wearing, graphite body, with minimalist matt black styling and discreet silver trims
- Rotor brake
- Anti-backlash system
- Micro line lay adjustment
- Rotor line guard
- 2 range casting line clips – one black, one silver
- Rotor Balanced Profile
- Twist free roller
- Pro-cast lip on spool
- 5 stainless steel ball bearings + 1 roller bearing
- Gear ratio: 4.6:1
- Weight: 560g

		*RRP
CRL069	FX9 Reel	£109.99
CRL068	FX9 - Spare Spool Standard	£24.99

0.30mm/330m 0.35mm/280m
0.33mm/310m 0.37mm/220m



EOS® 12000

- Matt black styling with understated graphics
- Hard-wearing graphite body
- Suited to general fishing and also use as a spool reel
- Quick front clutch with grit guard
- Pro-cast lip on spool
- Twist-Free roller
- Mesh-Tec gearing system
- Anti-Backlash system
- Rotor line guards
- Sprung line clip
- CNS system
- 7 stainless ball bearings + 1 roller bearing
- Spare spool options available separately
- Gear ration 4.5:1
- Weight 744g



0.34mm/375m 0.42mm/275m
0.39mm/300m

		*RRP
CRL074	EOS 12000 Reel	£99.99
CRL076	EOS 12000 - Spare Spool Shallow	£24.99
CRL077	EOS 12000 - Spare Spool Standard	£24.99
CRL078	EOS 12000 - Spare Spool Deep	£24.99

FEATURES



Sprung line clip on spool



Twist Free Roller on bail arm



Hardwearing graphite body

EOS® 12000FS

- Matt black styling with understated graphics
- Freespool facility at rear allows you to go from locked up to running clutch with flick of switch
- Suited to general fishing and also use on a marker rod
- Hardwearing graphite body
- Quick front clutch with grit guard
- Pro-cast lip on spool
- Twist-Free Roller
- Mesh-Tec gearing system
- Anti-Backlash system
- Rotor line guards
- Sprung line clip
- CNS system
- Stylish all black handle, spool and bail arm
- 10 stainless ball bearings + 1 roller bearing
- Spare spool options available separately
- Weight 843g
- Gear ratio: 4.2:1



0.34mm/375m 0.42mm/275m
0.39mm/300m

		*RRP
CRL075	EOS 12000FS	£129.99
CRL076	EOS 12000FS - Spare Spool Shallow	£24.99
CRL077	EOS 12000FS - Spare Spool Standard	£24.99
CRL078	EOS 12000FS - Spare Spool Deep	£24.99

FEATURES



Freespool facility at rear



Ergonomic handle



Adjustable tension for Freespool

EOS® 10000

- Ideal for smaller venues where casts under 90m are needed
- 5 stainless ball bearings
- Great line lay aids casting
- Smooth clutch
- Freespool facility at rear allows you to go from locked up to running clutch with flick of switch
- Weight 558g
- Rotor balanced profile
- Line-friendly line clip
- Gear ratio 5.5:1
- Large handle for cranking power
- Weight 558g



FEATURES



Anti-twist line roller



Easy to adjust, responsive front drag



Freespool facility with adjustable tension

		*RRP
CRL059	EOS 10000	£64.99
CRL060	EOS 10000 - Spare Spool	£19.99

0.33mm/320m
0.35mm/260m

NEW

EOS® 10000FD

- New addition to the EOS reel family
- Responsive front drag system
- Perfect for short to medium range fishing
- Also doubles up as a handy reel for floater fishing
- 5 Stainless Ball Bearings
- Great line lay aids casting
- Gear ratio 5.5:1
- Rotor balance profile
- Line-friendly line clip
- Large handle for cranking power
- Weight 540g
- Offers unrivalled value for money
- Spare spool available separately



FEATURES



Lightweight body balances perfectly with lower test curve rods



Easy to adjust front drag feature



Anti-twist line roller

		*RRP
CRL079	EOS 10000FD	£49.99
CRL080	EOS 10000FD - Spare Spool	£19.99

0.33mm/320m
0.35mm/260m



CAMO SOFT® STEEL

- Available in both Light and Dark Camo
- Low stretch and very strong
- Very supple, low diameter making it perfect casting
- Highly abrasion resistant
- Colour-break camouflage makes it very hard to spot on lakebed
- Great knot strength and low memory

			*RRP
CML132	Camo Light 0.30mm 13lb/5.90kg		£21.99
CML133	Camo Light 0.33mm 16lb/7.27kg		£21.99
CML134	Camo Light 0.35mm 18lb/8.18kg		£21.99
CML135	Camo Light 0.37mm 20lb/9.09kg		£21.99
CML136	Camo Dark 0.30mm 13lb/5.90kg		£21.99
CML137	Camo Dark 0.33mm 16lb/7.27kg		£21.99
CML138	Camo Dark 0.35mm 18lb/8.18kg		£21.99
CML139	Camo Dark 0.37mm 20lb/9.09kg		£21.99



TORQUE®

- Perfect all-round monofilament main line
- Offers unrivalled value for money
- Designed for anglers on a tight budget that still want Fox quality
- Low-visibility green colour that is perfect for clear water conditions
- Great abrasion resistance makes it ideal for weedy and snaggy venues
- Low diameter aids casting performance
- High knot strength
- Low memory and stretch
- 1000m per spool except 20lb (850m) & 25lb (750m)
- Available in 11lb (0.30mm), 13lb (0.33mm), 16lb (0.35mm), 20lb (0.38mm) and now 25lb (0.42mm)

			*RRP
CML145	Torque 0.30mm 11lb/5.00kg		£9.99
CML146	Torque 0.33mm 13lb/5.91kg		£9.99
CML147	Torque 0.35mm 16lb/7.27kg		£9.99
CML148	Torque 0.38mm 20lb/9.55kg		£9.99
CML157	Torque 0.42mm 25lb/11.73kg		£9.99



EXOCET® MONO TRANS KHAKI

- Trans Khaki colour, which is almost invisible in water
- Number one choice for many of the UK and Europe's leading carp anglers
- Low diameter and supple making it perfect for long-range casting
- Great abrasion resistance considering low diameter
- Sinks surprisingly well for such a supple line
- Great knot strength and low memory
- Supplied on 1000m bulk spools

			*RRP
CML149	Exocet Mono 0.26mm 10lb/4.55kg		£21.99
CML150	Exocet Mono 0.30mm 13lb/5.90kg		£21.99
CML151	Exocet Mono 0.33mm 16lb/7.27kg		£21.99
CML152	Exocet Mono 0.35mm 18lb/8.18kg		£21.99
CML153	Exocet Mono 0.37mm 20lb/9.09kg		£21.99
CML154	Exocet Mono 0.40mm 23lb/10.45kg		£21.99



EXOCET® TRANS KHAKI TAPERED MONO

- Low-visibility Trans Khaki blends virtually disappears on lakebed and in midwater
- Starts at a very strong 35lb (0.50mm) for 8m then tapers down over the next 6m to either 12lb (0.30mm) or 15lb (0.33mm) there is then 300m of 12 or 15lb line before it then tapers back up to the 35lb (again 6m of taper and 8m of 35lb).
- Ideal for venues where leaders are banned
- Perfect for distance casting
- Can achieve casts in excess of 180m!
- Double taper means the line can be reversed giving you greater value for money
- Very supple yet highly abrasion resistant
- Great knot strength and low memory
- Supplied on 300m spools

			*RRP
CML155	Exocet Tapered Line 12-35lb		£10.99
CML156	Exocet Tapered Line 15-35lb		£10.99



TRANS KHAKI TAPERED MONO LEADERS

- Designed to take 'shock' of casting a heavy lead or spod long distances and prevent 'crack-offs' from occurring
- Taper allows you to use a thick shockleader but only have a small knot attaching it to main line which aids the distances you can achieve
- Trans Khaki camouflage
- Low memory and low stretch
- Highly abrasion resistant
- 3 leaders per spool, each of 12m long
- Available in 12lb-30lb (0.33mm-0.50mm) and 16lb-35lb (0.37mm-0.57mm)

			*RRP
CML142	Edges Tapered Leader x 3 12-30lb		£9.99
CML143	Edges Tapered Leader x 3 16-35lb		£9.99



SNAG LEADER

- Highly abrasion resistant
- Low-stretch properties
- Perfect leader material when fishing snaggy and weedy venues
- Available in Clear and Camo
- Available in 25lb (11.3kg), 35lb (15.9kg) and 45lb (20.4kg)

			*RRP
CML062	Camo Leader 0.45mm 25lb/11.3kg		£10.99
CML063	Camo Leader 0.50mm 35lb/15.9kg		£10.99
CML064	Camo Leader 0.60mm 45lb/20.4kg		£10.99
CML065	Clear Leader 0.45mm 25lb/11.3kg		£10.99
CML066	Clear Leader 0.45mm 35lb/15.9kg		£10.99
CML067	Clear Leader 0.45mm 45lb/20.4kg		£10.99



SURFACE™

- Designed specifically for surface fishing
- Neutral buoyancy
- Low diameter and low visibility
- Ultra-supple for easy casting
- Very discreet when lying on water's surface
- Great abrasion resistance and tough knot strength
- Supplied on 250m spools

		*RRP
CML128	Surface 0.28mm 12lb/5.45kg	£8.99
CML129	Surface 0.30mm 15lb/6.80kg	£8.99



ILLUSION® TRANS KHAKI

- Features cutting edge technology that makes it our best fluorocarbon ever
- Developed alongside top diver Rob Hughes to ensure it disappears both on the lakebed and up in the water column
- Super-supple for smooth casting and following lakebed contours
- Extremely fast sinking
- Low stretch
- Invisible when in water
- Highly abrasion resistant
- Top quality knot strength
- Supplied on 200m spools
- 600m bulk spools also available in 19lb only

		*RRP
CML130	Illusion 200m 0.35mm 16lb/7.27kg	£21.99
CML131	Illusion 200m 0.39mm 19lb/8.64kg	£21.99
CML141	Illusion 600m 0.39mm 19lb/8.64kg	£54.99



EXOCET® MK2 MARKER BRAID

- Purposely designed for use on a marker reel
- Low visibility green colour reduces chances of carp spooking
- Designed specifically for feature-finding work
- Ultra-buoyant
- Virtually no stretch, which helps transmit every lump and bump on the lakebed back to your rod tip
- Low diameter and supple for distance casting
- High knot strength
- Recommend for use in conjunction with shockleader

		*RRP
CBL012	Exocet Marker 0.18mm 20lb/9.07kg	£29.99



SUBMERGE®

- Used by many of the best anglers across Europe on some of the most demanding venues
- Available in Dark Camo featuring our colour-break technology
- Fast sinking
- Low diameter and very supple for casting performance
- Supple nature helps it to hug lakebed contours
- Highly abrasion-resistant
- Virtually zero stretch
- Perfect for snaggy and weedy venues
- Available in 300m and 600m spools
- Available in 25lb, 40lb and 55lb breaking strains

		*RRP
CBL008	300m Submerge 0.16mm 25lb/11.3kg	£34.99
CBL010	300m Submerge 0.20mm 40lb/18.1kg	£34.99
CBL016	300m Submerge 0.30mm 55lb/24.9kg	£34.99
CBL009	600m Submerge 0.16mm 25lb/11.3kg	£69.99
CBL011	600m Submerge 0.20mm 40lb/18.1kg	£69.99
CBL017	600m Submerge 0.30mm 55lb/24.9kg	£69.99



HORIZON® SEMI BUOYANT BRAID

- Semi-buoyant design for fishing at extreme long range, which helps to keep the line above weed and snags
- Features the same Dark Camo colour as our Submerge sinking braid
- Highly abrasion-resistant making it perfect for snaggy and weedy venues
- High knot strength
- Very supple making it very smooth when casting
- Low diameter aids distance that can be cast
- Available in 35lb (0.20mm) and 50lb (0.30mm) versions
- Available on 300m spools

		*RRP
CBL014	Horizon 0.20mm 35lb/15.90kg	£32.99
CBL015	Horizon 0.30mm 50lb/22.73kg	£32.99



EXOCET® MK2 SPOD BRAID

- Hi-vis yellow braid designed specifically for spodding
- Ultra-buoyant makes it easier to retrieve your spod
- Virtually no stretch
- Low diameter and supple for distance casting
- High knot strength
- Recommend for use in conjunction with shockleader

		*RRP
CBL013	Exocet Spod 0.18mm 20lb/9.07kg	£29.99



SHELTERS

Our range of shelters must rank as one of the most comprehensive on the market, with all bases covered. We take shelter design very seriously, and with our team of consultants across Europe, we've worked very hard to bring you the best offerings at great value-for-money prices.

Whether you're a long-session angler looking for a large bivvy that offers unrivalled comfort; a short-session angler looking for a lightweight, fast-erect shelter; or a general carp angler wanting an all-round shelter that covers a host of styles; you're sure to find something suitable in the coming pages. We have a number of new shelters this year, including the R-Series range of bivvies and brollies, plus our EOS bivvies that are perfect entry-level designs for those on tight budgets, but who, as ever, desire Fox quality. We've also retained some of our classics, such as the Ultra Brollies, Easy Shelters and Easy Domes.

You'll also find a range of accessories at the end of the section, such as lighting and cookware. In these two categories we have some exciting new additions, including a host of bivvy lights and some great stoves!

NEW



R SERIES 2-MAN XL

- Available in both Khaki or unique Fox Camo pattern
- Hydrostatic head rating of 10,000mm
- Features O-Ring connections in inside to add the inner dome for increased comfort
- XL refers to the additional space and headroom created by the extra-high frame
- Classic four-rib step-forward design featuring an oversized peak for extra protection
- Rigid 19mm Aluminum frame and full-frame support supplied
- Porch support poles feature unique, pivoting moulded clips for perfect secure connection to the main frame
- Adjustable tension straps
- Large front and rear mozzly mesh panels
- Two-way letter box-style door with three door options, mozzly mesh, clear PVC and solid
- Front can be rolled back to create an open fronted shelter
- Two rod straps located at front of shelter
- Heavy-duty groundsheet and pegs supplied in an oversized heavy-duty carry bag
- Made from hard-wearing, breathable polyester fabric



2-MAN XL OVERWRAP

- Available in both Khaki or unique Fox Camo pattern
- Hydrostatic head rating of 10,000mm
- Designed to allow the user to create a twin skin on their R-Series 2-Man bivvy
- Increases warmth in the winter and helps to keep you cooler in the summer
- Vastly aids the reduction of condensation
- Creates additional storage space for items such as waders, bait etc.
- Large front and rear mozzly mesh panels
- Comes supplied with additional frame supports and storm poles with pivoting clips for perfect secure connection to the main frame
- Two-way letter box style door with three door options, mozzly mesh, clear PVC and solid
- Front can be rolled back to create an open fronted shelter
- Two rod straps located at front of shelter
- Made from hard-wearing, breathable polyester fabric
- Weight – 5kg

2-MAN XL INNER DOME

- Can be added to an R-Series 2-Man bivvy to create extra comfort, warmth and protection from insects and other annoying creatures
- Mesh inner dome features zip in/out groundsheet
- Can be packed away whilst attached to the bivvy with the groundsheet removed
- Main Fabric 100% polyester
- Weight – 2.5kg

FEATURES



Mozzly mesh rear vents for added airflow



Clear PVC door option supplied



Inner dome available separately



Inner dome features zip-in groundsheet



Mozzly mesh door and windows

		*RRP
CUM248	R Series 2 Man XL Khaki	£379.99
CUM249	R Series 2 Man XL Camo	£399.99
CUM250	R Series 2 Man XL Khaki inc. Dome	£469.99
CUM251	R Series 2 Man XL Camo inc. Dome	£479.99

		*RRP
CUM252	R Series 2 Man XL Dome Only	£99.99
CUM253	R Series 2 Man XL Khaki Wrap	£179.99
CUM254	R Series 2 Man XL Camo Wrap	£199.99

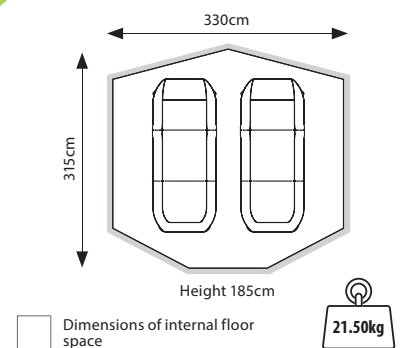

NEW



R SERIES 1-MAN XL

- Available in Khaki or unique Fox Camo pattern
- Hydrostatic head rating of 10,000mm
- Features O-Ring connections in inside to add an inner, mesh dome for increased comfort
- XL refers to the additional space and head room created by the extra high frame
- Classic three-rib pram-hood design featuring an oversized peak for extra protection
- Rigid 19mm Aluminum frame and full-frame support supplied.
- Porch support poles feature unique pivoting moulded clips for perfect, secure connection to the main frame
- Adjustable tension straps
- Large front and rear mozzie mesh panels
- Two-way letter box-style door with three door options, mozzie mesh, clear PVC and solid
- Front can be rolled back to create an open fronted shelter
- Two rod straps located at front of shelter
- Heavy-duty groundsheet and pegs supplied in an oversized heavy-duty carry bag
- Made from hard-wearing, breathable polyester fabric



1-MAN XL OVERWRAP

- Available in Khaki or unique Fox Camo pattern
- Hydrostatic head rating of 10,000mm
- Designed to allow the user to create a twin skin on their R-Series 1-Man bivvy
- Increases warmth in the winter and helps keep you cooler in the summer
- Vastly aids the reduction of condensation
- Creates additional storage space for items such as waders, bait etc.
- Large front and rear mozzie mesh panels
- Two-way letter box-style door with three door options: mozzie mesh, clear PVC and solid
- Made from hard-wearing, breathable polyester fabric

1-MAN XL INNER DOME

- Can be added to an R-Series 1-Man bivvy to create extra comfort, warmth and protection from insects and other annoying creatures
- Mesh inner dome features zip in/out groundsheet
- Can be packed away whilst attached to the bivvy (with the groundsheet removed)
- Main Fabric 100% polyester
- Weight – 1.8kg

FEATURES



Mozzie mesh rear vents for added airflow



Inner dome has matching rear vents



Inner dome available separately



Heavy-duty groundsheet supplied



Adjustable tension straps

		*RRP
CUM241	R Series 1 Man XL Khaki	£279.99
CUM242	R Series 1 Man XL Camo	£299.99
CUM243	R Series 1 Man XL Khaki inc. Dome	£339.99
CUM244	R Series 1 Man XL Camo inc. Dome	£359.99

		*RRP
CUM245	R Series 1 Man XL Dome Only	£79.99
CUM246	R Series 1 Man XL Khaki Wrap	£129.99
CUM247	R Series 1 Man XL Camo Wrap	£149.99

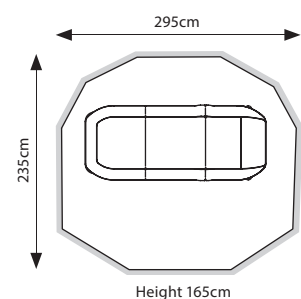

□ Dimensions of internal floor space

15.90kg

NEW



EOS® 1-MAN & 2-MAN

- Designed to offer unrivalled value for money
- Perfect shelter for newcomers or anglers on tight budgets
- 8000mm hydrostatic head fabric
- Two-rib, pram-hood design featuring a generous peak for extra protection
- Khaki colour
- Full-frame support supplied
- Two-way letter box-style door with integrated mesh insert plus PVC and solid panel options
- Front can be rolled back to create an open fronted shelter
- Two rod straps located at front of shelter
- Lightweight groundsheet and heavy-duty pegs supplied in a zipped carry bag
- Main outer fabric – 100% polyester
- Available in 1-Man and 2-Man options



1-MAN SKIN

- Designed to allow the user to create a twin skin on their EOS 1-Man bivvy
- Increases warmth in the winter and helps to keep you cooler in the summer
- Vastly aids the reduction of condensation
- Creates additional storage space for items such as waders, bait etc.
- 8000mm hydrostatic head
- Weight – 1.8kg



2-MAN SKIN

- Designed to allow the user to create a twin skin on their EOS 2-Man bivvy
- Increases warmth in the winter and helps keep you cooler in the summer
- Vastly aids the reduction of condensation
- Creates additional storage space for items such as waders, bait etc.
- 8000mm hydrostatic head
- Weight – 2.3kg

FEATURES



Supplied with clear PVC door option



Front can be rolled back to create open fronted shelter design



Generous peak gives added protection from elements



Integrated mozzie mesh door on front



Full-frame support supplied

		*RRP
CUM255	EOS 1-Man	£159.99
CUM256	EOS 1-Man Skin	£59.99
CUM257	EOS 2-Man	£179.99
CUM258	EOS 2-Man Skin	£69.99

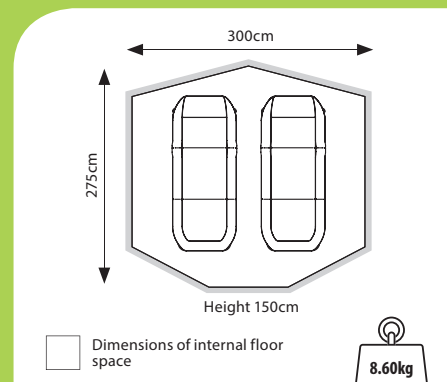
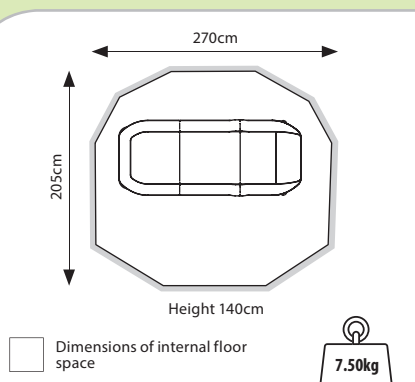



RETREAT+ 1-MAN & 2-MAN

- Quite possibly the most feature-packed pram-hood bivvy ever made!
- 20,000 hydrostatic head Ven-Tec Rip Stop material
- Rigid, lightweight aluminium poles
- Flat back combined with improved side angles gives maximum space both front to back and also side to side
- Break in the pole structure, increases internal space yet makes the bivvy more compact once packed away
- Fully-removable front
- Three door options supplied: Solid, Clear PVC and Mozy Mesh
- Two-way zips on all doors for barn-style opening
- Front peak for added protection from elements
- Mozy mesh window panels at front
- Rear and side mozy mesh vents for increased air flow
- Adjustable tension straps on side
- Two rod support straps on peak
- Mesh inner dome for added comfort available separately or can be purchased as part of a bivvy & dome package
- Mesh inner dome features zip-in groundsheet
- Can be packed away with mesh dome attached as long as groundsheet is zipped out
- Supplied with full-frame support, heavy-duty pegs, heavy-duty clip-in groundsheet and an oversized carry bag
- 2-Man bivvy also includes side support poles for peak and storm straps
- Extending wrap available separately
- Available in 1-Man and 2-Man options

EXTENDING WRAP

- 20,000 hydrostatic head Ven-Tec Rip Stop material
- Same three door options supplied as on bivvy: Solid, Clear PVC and Mozy Mesh
- Mozy mesh vents on rear and side mirror those on bivvy for added airflow when wrap is on
- Fully-removable front
- Creates twin skin effect to reduce condensation, give added warmth in winter and help keep you cool in summer
- Two rod support straps
- Increase overall footprint of bivvy by extending front
- Supplied with additional groundsheet extension
- Available in 1-Man and 2-Man options



		*RRP
CUM199	Retreat+ 1 Man	£499.99
CUM201	Retreat+ 1 Man Inner Dome	£109.99
CUM205	Retreat+ 1 Man Bivvy & Inner Dome	£529.99
CUM200	Retreat+ 1 Man Extending Wrap	£249.99
CUM202	Retreat+ 2 Man	£599.99
CUM204	Retreat+ 2 Man Inner Dome	£129.99
CUM206	Retreat+ 2 Man Bivvy & Inner Dome	£699.99
CUM203	Retreat+ 2 Man Extending Wrap	£329.99

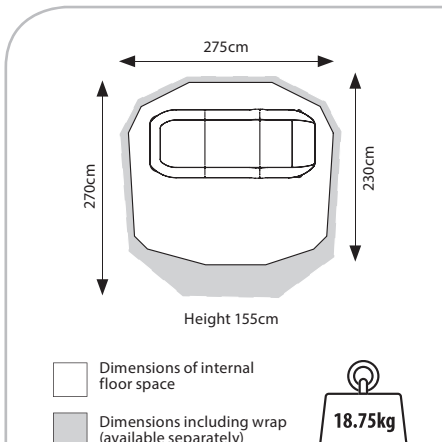

FEATURES



Mozy mesh door



Fully-removable front and inner dome



PVC door



Ven-Tec Rip Stop material



Side support bar

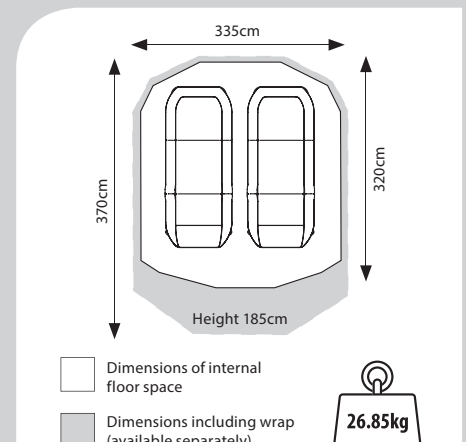

EASY SHELTER



EASY SHELTER

- Unique pop-up frame design for rapid erection and very fast pack away
- Perfect shelter for short-session angler who wants something that is light and compact to carry
- Ideal for tight swims where a traditional brolly or bivvy wouldn't fit
- Hard wearing Polyester fabric (2000mm hydrostatic head rating)
- Styled in unique Fox Camo pattern
- Can fit inside a bedchair when packed away for easy transportation
- Front peak gives protection from rain when door is open
- Can be pegged to the ground for maximum stability making it ideal for use as a day session shelter when not carrying a bedchair
- Solid front option features three vertical toggle fixings to allow you to roll the panel up in sections and peg out further to give increased coverage when in use
- Supplied with zip-in mozzie mesh front panel
- Large mozzie mesh panel at rear to aid air flow
- Both front panels feature letter box style door
- Designed to fit most standard sized bedchairs
- Rod straps either side of the door
- Supplied with three support ribs and heavy-duty pegs

CUM187 Easy Shelter Camo *RRP
£159.99

POP UP DESIGN...



FEATURES



Removable front



Mozzie mesh door



Pegged out adjustable front



Frame support



Can be packed inside a bedchair

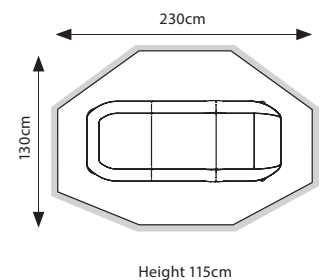

Dimensions of internal floor space

EASY DOME **FOX**



EASY DOME® MAXI 1-MAN & 2-MAN

- Innovative frame design that features additional rear rib for flat-back profile, allowing for increased usable internal space
- Additional rib also increases stability
- Rear mozzey mesh vents for increased airflow
- 100% Polyester fabric with 6,000mm hydrostatic head
- Fully-removable front
- Aerograde aluminium poles
- Unique Fox Snap Lock elbows
- Fully-removable front panel system
- Mozzey mesh front side panels
- Velcro rod retaining straps
- Removable inner mozzey mesh sleeping compartment with newly designed removable PE groundsheet (easier to pack away and clean)
- Integrated guy ropes for extreme weather situations
- Easy and speedy erection time
- Supplied with mozzey mesh, solid and PVC door options
- All doors have two way zips for barn-style opening
- Supplied with pegs and newly-designed carry bag
- Heavy-duty groundsheet available separately

		*RRP
CUM190	Easy Dome Maxi 1-Man	£399.99
CUM191	Easy Dome Maxi 2-Man	£449.99
CUM193	1-Man Heavy-duty Groundsheet	£34.99
CUM194	2-Man Heavy-duty Groundsheet	£39.99

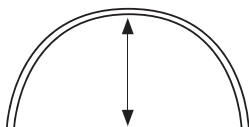

1-MAN

- Max height inside tent 138cm
- Height back from bottom to rib 134cm
- Height front from bottom to rib 134cm
- Door opening from bottom to zip 118cm
- Door opening at widest point 92cm

2-MAN

- Max height inside tent 154cm
- Height back from bottom to rib 148cm
- Height front from bottom to rib 148cm
- Door opening from bottom to zip 132cm
- Door opening at widest point 93cm

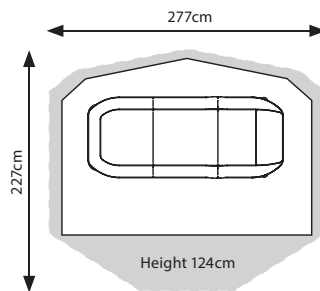

- Dimensions of internal floor space
- Dimensions including wrap (available separately)

14.30kg

FEATURES



Mozzey mesh door



PVC door



Removable front



Solid front door



Barn-style door

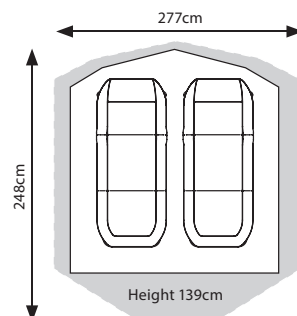

- Dimensions of internal floor space
- Dimensions including wrap (available separately)

15.35kg



ROYALE® COOK TENT STATION

- Spacious design to accommodate all cooking apparatus and food for long sessions
- Creates a fantastic social area for your fellow anglers to enjoy
- Steel frame construction
- Same hard-wearing breathable 5000 hydrostatic head polyester fabric as used on Royale XXL bivvy
- Mozyzy mesh panel at rear to aid airflow inside
- Zip-in groundsheet
- Supplied with Solid, Clear PVC and Mozyzy Mesh front panel options
- Front door can be converted with two extra-long banksticks (supplied) to create a porch area for extra space
- Access point at rear for electric cables or gas pipes for fridges, cookers etc
- Supplied with guy ropes on each corner and on front of porch for extra stability
- Heavy-duty pegs supplied
- Supplied in heavy-duty carry bag
- Main outer fabric: 100% Polyester
- Hydrostatic head 5000mm

*RRP

CUM183 Royale Cook Tent Station £219.99

FEATURES



Zip-in heavy-duty groundsheet



Clear PVC front panel option



Mozyzy mesh front panel option



60INS BROLLY

- A simple 60ins broly design, which features a removable central pole
- The pole can be positioned Nu-broly style and used with or without storm poles - this means the central pole can be removed and repositioned parallel to the back of the broly. The pole can then be pushed into the ground to offer coverage without the pole being in the way
- Two storm caps are included for optional use of storm poles (not included)
- Hardwearing Khaki-coloured polyester fabric (2000mm hydrostatic head)
- Perfect for short day sessions or for extra cover when entertaining visitors

*RRP

CUM216 60" Broly £74.99

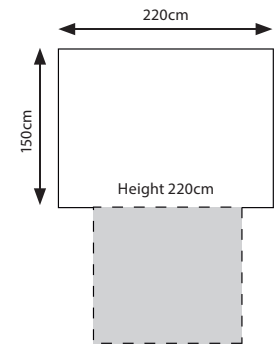

- Dimensions of internal floor space
- Dimensions including wrap (available separately)

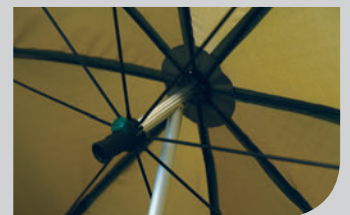

Can also be positioned NU-broly style



Rear pegging points



ULTRA 60 BROLLY

- Available in either Khaki or Fox Camo
- Features Ventec Rip Stop fabric with a 20,000mm hydrostatic head
- Features a full zip on the front to allow an optional Ultra Brolly Full Front or Ultra Brolly Camo Mozzy Screen to be added at a later date
- Supplied with removable internal vapour shield to help reduce condensation and aid comfort (vapour shield can be left attached when packed away)
- Features button-release STS-equipped mechanism, which allows for maximum headroom
- 60ins (152cm) design with 8mm Fibreglass frame for incredible stability
- Four back ribs touch the ground for added stability
- Extended side skirts provide extra protection from the elements
- Rear mozzy mesh vents for added airflow
- Front drain pipe diverts rainwater
- Other features include: rod retaining straps, multiple pegging points for adjustable brolly height, compression bell cap with rubber gasket seal
- Short threaded centre pole for ease and speed when erecting
- Four storm caps (supplied with two 24ins side storm poles)
- Protective caps to secure the side storm poles when folded into the brolly once packed away
- Also supplied with: full-size heavy-duty groundsheet, heavy-duty pegs and heavy-duty carry bag with full-length zip
- Main outer fabric: 100% Polyester

CAMO MOZZY SCREEN

- Unique Fox Camo styling
- Full-length integrated zip, which attaches to an open-front Ultra Brolly or Ultra Brolly Camo
- Two-way zips on door to create letter box opening
- Elasticated toggle attachments for front storm poles
- Main outer fabric: 100% Polyester



FEATURES



STS-equipped mechanism



Mozzy mesh vents at rear



Compression bell cap with rubber gasket



Multiple pegging points



Internal vapour shield supplied

		*RRP
CUM219	Ultra 60 Brolly Khaki	£269.99
CUM221	Ultra 60 Brolly Camo	£289.99
CUM223	Ultra 60 Brolly Mozzy Screen Camo	£39.99

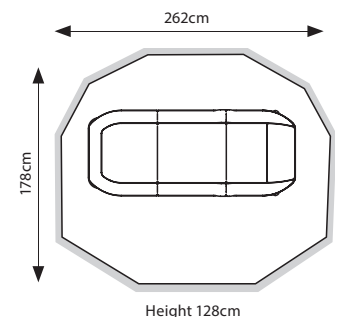

□ Dimensions of internal floor space





ULTRA 60 BROLLY SYSTEM

- Available in either Khaki or Fox Camo
- Features Ventec Rip Stop fabric with a 20,000mm hydrostatic head
- Supplied with zip-on, fully-removable Ultra Brolly Full Front that features three door options: clear PVC, Solid and Mozzy Mesh
- All doors on front feature two-way zips to create letter box opening
- Front panel also features side mozzy mesh windows for added airflow and increased visibility whilst still being protected from bugs
- Optional Ultra Brolly Camo Mozzy Screen can be added at a later date
- Supplied with removable internal vapour shield to help reduce condensation and aid comfort (vapour shield can be left attached when packed away)
- Features button-release STS Equipped mechanism, which allows for maximum headroom
- 60ins (152cm) design with 8mm fibreglass frame for incredible stability
- Four back ribs touch the ground for added stability
- Extended side skirts provide extra protection from the elements
- Rear mozzy mesh vents for added airflow
- Front drain pipe diverts rainwater
- Other features include: rod-retaining straps, multiple pegging points for adjustable broolly height, compression bell cap with rubber gasket seal
- Short-threaded centre pole for ease and speed when erecting
- 4 storm caps (supplied with 2 x 36ins front and 2 x 24ins side storm poles)
- Protective caps to secure the side storm poles when folded into the broolly once packed away
- Also supplied with: full-size heavy-duty groundsheet, heavy-duty pegs and heavy-duty carry bag with full-length zip
- Main outer fabric: 100% Polyester

INFILL PANEL

- Available in either Khaki or Fox Camo
- Full-length integrated zip, which attaches to an open front Ultra Brolly to convert it into a full system
- Large mozzy mesh side windows for added airflow and increased visibility whilst still being protected from bugs
- Three door options: Clear PVC, Solid and Mozzy Mesh
- All doors on front feature two-way zips to create letter box opening
- Main outer fabric: 100% Polyester



		*RRP
CUM220	Ultra 60 Brolly System Khaki	£389.99
CUM222	Ultra 60 Brolly Camo	£399.99
CUM224	Ultra 60 Brolly Infill Panel Khaki	£129.99
CUM225	Ultra 60 Brolly Infill Panel Camo	£134.99

FEATURES



Front drain pipe diverts water



System supplied with three door options: Solid...



...Clear PVC...



...and Mozzy Mesh



Front is fully-removable on System

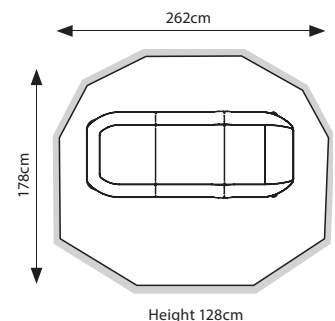

□ Dimensions of internal floor space

12.90kg

NEW

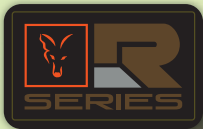

R SERIES BROLLY

- Space-saving mechanism for increased internal headroom
- Four ribs contact the ground for greater stability
- Extended side skirts provide extra protection from the elements
- Front drain pipe diverts rainwater
- Short-threaded centre pole for ease and speed when erecting shelter
- Four storm caps (supplied with 2 x 24ins side storm poles)
- Features a full-length zip on the front to allow an optional R-Series Infill Panel, Extension or Mozzy Panel (all available separately) to be added at a later date
- 10,000mm hydrostatic head
- Lightweight full-sized groundsheet
- Outer Fabric - 100% Polyester



INFILL PANEL

- Full-length integrated zip, which attaches to the open front of an R-Series Brolly to convert it into a full system
- Three door options: Clear PVC, Solid Khaki and Mozzy Mesh.
- All doors have 2 way zips to create letter box opening
- 10,000mm hydrostatic head
- Weight: 800g
- Main outer fabric: 100% Polyester



BROLLY EXTENSION

- Full-length integrated zip, which attaches to the open front of an R-Series Brolly or Brolly System to convert it into a 2-man brolly shelter
- Aluminum frame and supports
- Features a full zip on the front to allow the R-Series Infill Panel or Mozzy panel to be added
- 10,000mm hydrostatic head
- Lightweight extending groundsheet
- Creates a 1metre extension to the front of the R Series Brolly
- Does not fit Ultra Brolly
- Weight: 3.25kg
- Main outer fabric: 100% polyester

FEATURES



Space-saving mechanism for increased headroom



Multiple pegging points



Front drain pipe diverts rainwater



Compatible with R-Series Brolly Extension



Brolly Extension converts brolly into two-man

		*RRP
CUM260	R Series Brolly	£139.99
CUM261	R Series Brolly Infill Panel	£79.99
CUM263	R Series Brolly Extension	£79.99

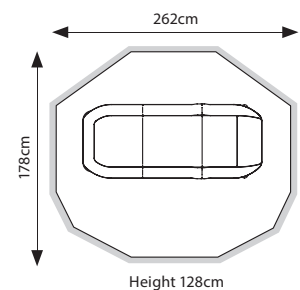

□ Dimensions of internal floor space

7.50kg

NEW



R SERIES BROLLY SYSTEM

- Space-saving mechanism for increased internal headroom
- Four ribs contact the ground for greater stability
- Extended side skirts provide extra protection from the elements
- Front drain pipe diverts rainwater
- Supplied with zip-on, fully-removable R-Series Brolly Infill Panel that features three door options: Clear PVC, Solid Khaki and Mozy Mesh
- All doors have 2 way zips to create letter box opening
- Optional full Mozy Infill Panel and Brolly Extension can be added at a later date
- Short-threaded centre pole for ease and speed when erecting
- Four storm caps (supplied with 2 x 24ins side storm poles and 2 x 36in front storm poles)
- 10,000mm hydrostatic head
- Lightweight full-sized groundsheet
- Outer Fabric: 100% Polyester

R SERIES MOZZY PANEL

- Full-length integrated zip which attaches to the open front of an R-Series Brolly or R-Series Brolly Extension
- Two way zips on the door to create letter box opening
- Elasticated toggle attachments for the front storm poles
- Weight: 750g
- Main outer fabric: 100% polyester



		*RRP
CUM259	R Series Brolly System	£219.99
CUM262	R Series Brolly Mozy Panel	£34.99

FEATURES



Front features three door options: Mozy Mesh...



...Clear PVC...



...and Solid - all of which can be used letter box style



Full Mozy panel can be attached to front



Space-saving mechanism for increased headroom

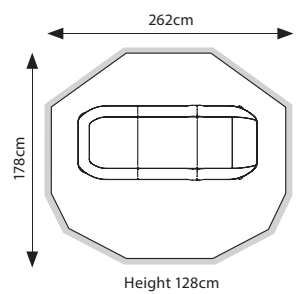

 Dimensions of internal floor space

 **9.00kg**

*RRP - Recommended retail price



BIVVY TABLE

- Surface dimensions measure: 49cm x 29cm
- Features two compartments: large for a System F Box and smaller for items such as keys, phone, rig bits etc.
- Special non-slip coated surface
- Legs extend to 33cm and are secured by Fox Cam Loks
- Large swivel feet for stability on soft ground

CAC053 Bivvy Table *RRP
£44.99

ROYALE® SESSION XL TABLE

- Perfect for long-session angler
- Fold-flat design
- Four extendable legs with easy to use adjustment. Min/Max height 45-60cm
- Protective table top cover supplied
- Compact when folded away - supplied with carry bag
- Surface dimensions measure: 79cm x 59cm

CAC427 Royale Session XL Table *RRP
£79.99

NEW



CAMO BIVVY/ROD MAT

- Neoprene mat that can be used in your bivvy doorway
- Styled in unique Fox Camo print
- Heavy-duty waterproof backing fabric
- 70cm x 50cm

CUM264 Camo Bivvy Mat *RRP
£14.99



WARRIOR® BIVVY TABLE

- Table top dimensions: 47cm x 31cm
- Designed to accommodate a large System F Box
- Extendable legs with Cam Lok fittings
- Legs extend to 31cm
- Fold flat design
- Comes in carry bag

CAC357 Warrior Bivvy Table *RRP
£34.99

SESSION TABLE

- Surface dimensions: 51cm x 34cm
- Special non-slip-coated surface
- Legs extend to 33cm and are secured by Fox Cam Loks
- Large swivel feet for stability on soft ground

CAC187 Session Table *RRP
£49.99



PLATFORM 'S' PEG x 15

- Perfect for pegging your shelter down on wooden platforms
- Ergonomic handles
- Hard-wearing steel point and thread
- 15 in a packet

CUM142 Platform S Pegs x 15 *RRP
£15.99



HEAT TRANSFER KETTLE

- Features Heat Transfer Technology that helps to concentrate the flame of your stove on the base of the kettle for much faster boiling time
- Design taken from the camping industry
- Made from a hard anodised aluminium and features a durable soft-touch handle
- Approximately 33% more efficient than traditional camping kettle, which boils the kettle fast and saves you money!
- Available in 0.9L and 1.5L versions

		*RRP
CCW005	Heat Transfer Kettle 0.9L	£26.99
CCW006	Heat Transfer Kettle 1.5L	£29.99



WINDSHIELD

- Shields your stove from the wind allowing for greater fuel efficiency
- Lightweight aluminium construction
- Comprises seven hinged panels
- Features pegging pins to aid stability on soft ground
- Supplied with a handy carry bag
- Available in two sizes: Standard and XL

		*RRP
CCW004	Windshield	£11.99
CCW008	XL Windshield	£14.99



3-PIECE MEDIUM COOKSET

- Supplied with frying pan, medium saucepan and 0.9L Heat Transfer Kettle
- Compact for transportation - saucepan sits inside the frying pan and the kettle inside the saucepan
- Thicker aluminium wall than other pans on the market, allowing a higher quality non-stick coating to be applied
- Supplied with a drawcord mesh carry bag
- The pans feature durable folding handles to allow them to be packed away compactly
- Compatible with Camo Cookset Bag (see page 72)

		*RRP
CCW001	Medium 3pc Set	£59.99



4-PIECE LARGE COOKSET

- Supplied with larger frying pan, large saucepan, medium saucepan and 0.9L Heat Transfer kettle
- Compact for transportation - kettle sits inside medium saucepan, which then sits inside large saucepan which then sits inside frying pan
- Thicker aluminium wall than other pans on the market, allowing a higher quality non-stick coating to be applied
- Supplied with a drawcord-mesh carry bag
- The pans feature durable folding handles to allow them to be packed away compactly
- Compatible with Camo Cookset Bag (see page 72)

		*RRP
CCW002	Large 4pc Set	£69.99

NEW



MICRO 2600 STOVE

- Compact design that screws to top of gas canister
- Adjustable flame control
- Manual ignition
- Power: 8871 BTU (2600W)
- Weight: 80g
- Designed for use with EN417 Butane-Propane mixed gas cartridge



COMPACT 3000 STOVE

- Compact and durable gas stove
- Adjustable flame control
- Manual ignition
- Power: 10236 BTU (3000W)
- Weight: 220g
- Designed for use with EN417 Butane-Propane mixed gas cartridge



HEAT TRANSFER 3200 STOVE

- Sturdy and durable gas stove
- Adjustable flame control
- Built-in Piezo ignition
- Power: 10919 BTU (3200W)
- Weight: 320g
- Designed for use with EN417 Butane-Propane mixed gas cartridge

		*RRP
CCW012	Cookware Micro 2600 Stove	£19.99
CCW010	Cookware Compact 3000 Stove	£29.99
CCW011	Heat Transfer 3200 Stove	£49.99

NEW

HALO

HALO® POWER MULTI LIGHT

- Multi-purpose LED light
- Can be used as a bivvy light to aid night-time photography and also a power source for charging mobile devices
- 6000mAh Polymer Lithium battery that is USB rechargeable
- Built in solar charging panel (150mAh/h)
- Four brightness settings: 500 lumens, 250 lumens, 100 lumens and 10 lumens
- Light run time: 4.5-hours in High mode
- Built-in adjustable stand which features magnets
- Screw thread in base for attachment to bankstick (use thread adaptor) or tripod
- Battery power indicator
- Simple on/off switch
- Also supplied with USB charging cable
- Dimension: 128mm x 85mm x 33mm
- Weight: 320g
- Important note: Re-charge battery every 3 months if not being used for a long time. The battery will only reach full performance after a few complete charging and discharging cycles.



CEI168 Halo Power Multi Light ^{*RRP} £59.99

HALO® POWER LIGHT

- Handy bivvy light that can also be used to charge your mobile devices
- 9900mAh Li battery that is USB rechargeable
- Three brightness settings – High (400 lumens), Medium (150 lumens) and Low (15 lumens)
- Supplied with karabiner hanging loop
- Features magnetic base
- Light run time: 12-hours in High mode
- Also supplied with USB charging cable
- Dimension: 65mm x 65mm x 80mm
- Weight: 315g
- Important note: recharge battery every 3 months if not being used for a long time. The battery will only reach full performance after a few complete charging and discharging cycles.



CEI170 Halo Power Light ^{*RRP} £49.99

HALO® BIVVY LIGHT

- Compact, easy-to-use bivvy light
- Features 9 x Samsung white LEDs plus 2 x red LEDs
- Powered by 2 x AA or 1 x CR123A batteries (not included)
- Four brightness settings: 200 lumens, 100 lumens, 50 lumens and 15 lumens
- Two colour options: White or Red
- Supplied with hanging loop and magnetic base plate
- Light run time: 7-hours in High mode
- Dimension: 70mm x 60mm x 46mm
- Weight: 60g (excluding battery)



CEI171 Halo Bivvy Light ^{*RRP} £15.99

FEATURES



Battery power indicator



Can also be used as a power source



Carabiner hanging loop



Can also be used as a power source



Supplied with hanging loop and magnetic base plate



HALO® 200 HEADTORCH

- 200 lumens
- Adjustable brightness (High -200, Medium-100, Low-20 lumens)
- Flashing mode at 25 lumens
- Single elasticated, adjustable headband
- Batteries are positioned at front in head section
- Adjustable-angle projection
- Single-button operation
- 1 x 3w Gen, two LG White LED bulb
- Supplied with 3 x AAA alkaline batteries
- Weight including batteries: 88g

*RRP

CEI161 Halo 200 Headtorch £24.99

NEW



HALO® MULTI COLOUR HEADTORCH

- Three colour options – White, Green and Red
- Four white brightness settings – 350 lumens, 250 lumens, 140 lumens and 90 lumens
- Two-button operation (one for colour and one for brightness)
- Adjustable-angle projection
- Single, elasticated, adjustable headband
- Runs on 3 x AAA batteries (not included)
- Weight: 68g

*RRP

CEI169 Halo Multi-Colour Headtorch £24.99



HALO® MS250 HEADTORCH

- 250 lumens
- Adjustable brightness (High -250, Medium-100, Low-10 lumens + 3mm LED setting of 15 lumens)
- Bulb type: 1 x Luxeon TX White LED + 2 x 3mm Nichia White LEDs
- Motion sensor (not only useful when tying rigs/cooking, but can be set up on a bankstick by your rods for security)
- Single elasticated, adjustable headband
- Batteries are positioned at rear in separate case (47mm x 89mm x 29mm), which also features light diffuser (ideal for other anglers to see you when you are out in water on a boat)
- Battery power indicator: turn rear light on, Green LED is high power, Red LED is low power
- Adjustable-angle projection
- Two button operation
- Supplied with 3 x AAA alkaline batteries
- Weight including batteries: 135g

*RRP

CEI162 Halo MS250 Headtorch £39.99



USB

HALO® MS300C HEADTORCH

- 300 lumens
- Adjustable brightness (High -300, Medium-100, Low-10 lumens + 3mm LED setting of 15 lumens)
- Bulb type: 1 x Luxeon TX White LED + 2 x 3mm Nichia White LEDs
- USB Rechargeable Li-polymer built-in battery supplied
- Also supplied with Micro USB charging cable
- Motion sensor (not only useful when tying rigs/cooking, but can be set up on a bankstick by your rods for security)
- Single elasticated, adjustable headband
- Charging status indicator on rear: red light indicates charging, green light indicates fully charged
- Battery is positioned at rear in separate case (47mm x 89mm x 29mm), which also features light diffuser (ideal for other anglers to see you when you are out in water on a boat)
- Two button operation
- Weight including battery: 130g
- Important Note: recharge battery every three months if not being used for a long time. The battery will only reach full performance after a few complete charging and discharging cycles

*RRP

CEI163 Halo MS300C Headtorch £49.99



HALO® AL320 HEADTORCH

- 470 lumens in 'boost' mode
- Adjustable brightness (High -320, Medium-150, Low-25 lumens)
- Bulb type: 1 x XP-G2 Cree White LED
- Light unit made from a hardwearing anodised aluminium
- Single elasticated, adjustable Camo headband
- Batteries are positioned at rear in separate case (53mm x 76mm x 34mm), which also features a red light
- Adjustable-angle projection
- Side operation button for front light
- Supplied with 3 x AA alkaline batteries
- Weight including batteries: 195g

*RRP

CEI164 Halo AL320 Headtorch £44.99



USB

HALO® AL350C HEADTORCH

- 500 lumens in 'boost' mode
- Adjustable brightness (High-350, Medium-150, Low-25 lumens)
- Bulb type: 1 x XP-G2 Cree White LED
- Light unit made from a hardwearing anodised aluminium
- USB Rechargeable Li-ion battery supplied
- Also supplied with Micro USB charging cable
- Single elasticated, adjustable Camo headband
- Battery is positioned at rear in separate case (38mm x 102mm x 35mm), which also features single button operation red light
- Side operation button for front light
- Charging status indicator on rear: red light indicates charging, green light indicates fully charged
- Weight including battery: 190g
- Important Note: recharge battery every three months if not being used for a long time. The battery will only reach full performance after a few complete charging and discharging cycles

*RRP

CEI165 Halo AL350C Headtorch £59.99



BEDCHAIRS, CHAIRS & SLEEPING BAGS

Bedchairs, chairs and sleeping bags won't catch more fish right? Well, we don't think it's that simple. Let us explain...

Here at Fox we believe motivation is one of the key drivers of success in carp fishing. If you look at the very best carp anglers across Europe, they all share one thing in common: they're extremely motivated and put 100% effort into everything they do. We believe bankside comfort plays a huge part in an angler's motivation... if you sleep well and are relaxed, then you'll enjoy your time on the bank, have increased energy levels and will be able to track down those fish.

Over the coming pages you'll find several established classics, such as the multi-award-winning Flatliner and Flatlitter MK2 bedchairs, the immensely popular Super Deluxe Recliner chair, the market-leading Warrior 2 chair range, as well as quality sleeping bags like the VR and ERS. Additionally, we've some new offerings, including two new models of Duralite chair, a larger version of our top-selling Warrior sleeping bag and two VRS Camo sleeping bag covers...



FEATURES

FX FLATLINER® BEDCHAIR

- The 'Flip-Cam System', is a very special piece of innovation. All other bedchairs, once unfolded, have the cams pointing upwards and as we all know, they are a real inconvenience. Not only do they get in the way, they also reduce the width of the mattress that you can actually utilize. This, however, is now a thing of the past as the cam on the Flatliner swivels 180 degrees so that it points downwards
- 'Twist-Lok' legs, which can be operated with one hand. Simply twist the mechanism on the leg and the foot will fall into position. Then let go of the mechanism and it will automatically lock the leg into position – it couldn't be easier!
- The Flatliner features a unique 'Double Hinge Bracket' on the foot-end that has been designed to create a void inside the bedchair when it is folded away. This therefore allows enough space for a standard-sized 3-season sleeping bag to be folded inside. Some other bedchairs achieve this by putting an angle in the actual frame at the head end, which severely hinders your sleeping position and comfort as you cannot lie flat!
- 'Even Flow' elastic has several benefits. Most other bedchairs use at least four lengths of elastic, whereas the Flatliner uses only two, which start and finish at the head and foot ends and also run through the Cam (unlike any other bedchair on the market). This means that there are no sections of the mattress that are not elasticated, giving a much more consistent tension and firmer feel to the mattress

- Mattress utilizes eyelets instead of unnecessary fabric loops. Eyelets allow the elastic to stretch when you sit on the bedchair and then retract when you get off it. In addition the eyelets have been very carefully positioned around the perimeter of the mattress to ensure maximum support is achieved. They are positioned as close as they can be to the legs to ensure an even tension on the mattress
- The frame is constructed from an oval aluminium, which is not only incredibly strong, but also makes the frame surprisingly light
- High-density foam mattress that is fleece-covered and also a staggering 50mm deep!
- Three legged
- Six large mud feet
- Main outer fabric: 100% Polyester
Padding/Filling: 100% Polyurethane

CBC039	FX Flatliner Bedchair	*RRP £329.99
--------	-----------------------	-----------------



Even Flow elastic on standard Flatliner gives more consistent tension to mattress

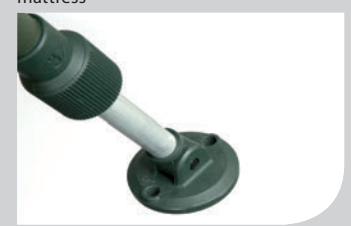

Twist-Lok Leg - simply twist the mechanism on the leg with one hand for instant and infinite adjustment



Double Hinge Bracket at the foot end. This creates a void when folded to store a standard 3 season bag



High-density foam mattress that is fleece-covered and also a staggering 50mm deep!

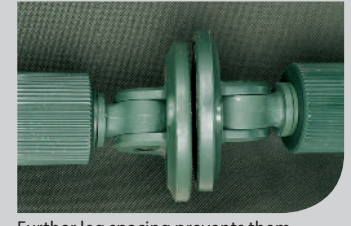

Further leg spacing prevents them from overlapping when the bedchair is packed away

REVOLUTIONARY FLATLINER 'FLIP-CAM SYSTEM'

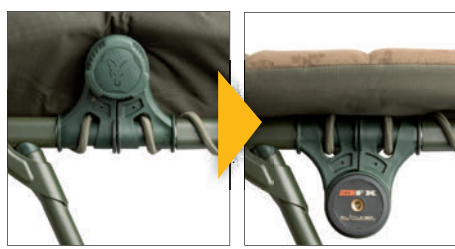

Standard Flatliner
Min height: 40cm
Max height: 48cm



FLATLITER
BED AND BAG SYSTEM
MK2



FX FLATLITER® BED & BAG SYSTEM MK2

- Double Hinged Bracket at both head and foot end, eliminating need for cams
- Two side tension straps that go around frame rather than mattress make it possible to fold away more compactly with sleeping bag attached
- Velcro strips on underside of mattress for use with Aquos covers (can secure cover to bed on the side you don't need to exit to keep warmth in)
- High-density foam on mattress for greater comfort
- One-piece lumbar support on middle and head sections give a much firmer mattress and prevents sagging
- Unique leg design with single legs at both head and foot end for increased stability and reduced weight; this means you have only 6 legs rather than 8 but still have full support at both ends
- 'Twist Lok' mechanism for infinite leg adjustment as used on Flatliner bedchair
- Large mud feet
- Two sizes available: Standard and Compact
- Main outer fabric: 100% Polyester
Padding: 100% Polyurethane

SUPPLIED BAG FEATURES

- Bag attaches to bed via full-length zip around edge of mattress to allow greater movement when inside the bag
- Bag lining on bottom half is polyester (allows easy movement inside bag) and top half is fleece (aids warmth and comfort)
- Top-quality hollow fill used, which aids warmth and is also much softer, enabling bag to sculpt around your body
- Larger internal zip baffle to keep warmth in and cold out
- Sleeping bag is rated as a 3-4 season
- Heavy-duty 10mm snag-free, crash zips on sleeping bag
- 20% of the bags filling is below you and the other 80% is above you to prevent heat loss
- Main outer fabric: 100% Polyester
Filling: 100% Polyester, Lining: 100% Polyester

		*RRP
CBC050	Flatliter Bed & Bag System Standard	£369.99
CBC051	Flatliter Bed & Bag System Compact	£339.99

214cm

87cm

Standard Flatliter
Min height: 40cm
Max height: 50cm

13.30kg

200cm

80cm

Compact Flatliter
Min height: 35cm
Max height: 45cm

12.60kg

FEATURES



Double hinge enables sleeping bag to be folded up inside in a compact manner



Single support legs at each end for extra stability



Lumbar support prevents sagging and makes mattress much firmer



Sleeping bag attaches to bed via one heavy duty zip



R-SERIES CAMO

- Available in three sizes: R1 (Compact), R2 (Standard) and R3 (Kingsize)
- Flat profile for maximum comfort
- Cam-free design for maximum usable width
- Full lumbar support to ensure firm mattress with no sagging
- Fleece-lined, padded mattress
- Features Fox Camo pattern on trim
- Extra padding at head end
- Double hinges allow for a sleeping bag to be folded inside
- Unique side tension straps ensuring bed is compact when packed away
- Large swivelling mud feet
- 6 adjustable legs
- Main outer fabric: 100% Polyester
Padding: 100% Polyurethane

*RRP

CBC054	R1 Camo Bedchair	£149.99
CBC055	R2 Camo Bedchair	£169.99
CBC056	R3 Camo Bedchair	£199.99

FEATURES



Side compression straps enable bed to pack away more compactly with sleeping bag attached



Lumbar support prevents sagging and makes mattress firmer



R1 Camo: 85cm x 205cm
Min height: 30cm / Max height: 40cm

12.60kg

R2 Camo: 98cm x 212cm
Min height: 36cm / Max height: 46cm

13.00kg

R3 Camo: 101cm x 223cm
Min height: 40cm / Max height: 50cm

13.80kg



WARRIOR® II STANDARD & XL

- Entry-level bed that is designed for newcomers and anglers on a tight budget that still want Fox quality
- Offers outstanding value for money
- Cam-free design giving more usable width
- Flat frame design with padded, foam mattress for maximum comfort
- Six extendable legs with swivelling mud feet for uneven ground
- Strap and buckle system allows bed to be packed away compactly with a sleeping bag on
- Main outer fabric: 100% Polyester
Padding: 100% Polyurethane

*RRP

CBC070	Warrior II Six Legged Bedchair	£119.99
CBC071	Warrior II Six Legged XL Bedchair	£139.99



Strap and buckle allows compact packaway



High-quality frame

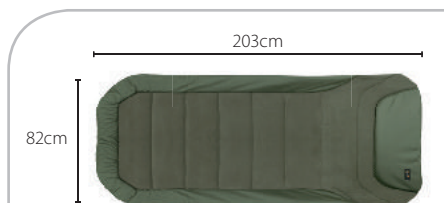

Standard Warrior II

Max height: 40cm
Folded: 82cm x 82cm x 21cm

9.00kg



XL Warrior II

Max height: 42cm
Folded: 89cm x 100cm x 21cm

13.75kg

NEW

Height: 33-40cm
Seat depth: 40cm
Seat width: 47cm
Back height: 52cm



2.90kg

DURALITE® LOW CHAIR

- Based on top-selling Duralite chair, but for anglers that prefer a lower chair without armrests
- Strong, but exceptionally lightweight Duralite Magnesium Alloy Construction
- 3D Mesh and polyester padded seat aids comfort whilst helping to keep overall weight low
- Fully adjustable legs that lock into position
- Large swivelling mud feet
- Main outer fabric: 100% Polyester, padding/filling: 100% Polyurethane

*RRP

CBC072 Duralite Low Chair £79.99

Height: 33-40cm
Seat depth: 52cm
Seat width: 55cm
Back height: 70cm



3.75kg

DURALITE® XL CHAIR

- Based on top-selling Duralite chair, but for anglers that prefer a bigger chair with a higher back
- Armrests for extra comfort
- Strong but exceptionally lightweight Duralite Magnesium Alloy Construction
- 3D Mesh and polyester padded seat aids comfort whilst helping to keep overall weight low
- Fully adjustable legs that lock into position
- Large swivelling mud feet
- Main outer fabric: 100% Polyester, padding/filling: 100% Polyurethane

*RRP

CBC073 Duralite XL Chair £109.99

Height: 33-40cm
Seat depth: 40cm
Seat width: 47cm
Back height: 52cm



3.20kg

DURALITE® CHAIR

- Strong but exceptionally lightweight Duralite Magnesium Alloy construction
- 3D mesh and polyester padded seat aids comfort whilst helping to keep overall weight low
- Fully-adjustable legs that lock into position
- Armrests for added comfort
- Large Swivelling mud feet
- Main outer fabric: 100% Polyester, padding/filling: 100% Polyurethane

*RRP

CBC059 Duralite Chair £94.99

Height: 36-43cm
Seat width: 53cm
Back height: 53cm
Folded: 64x57x20cm



5.50kg

R1 CAMO RECLINER CHAIR

- Smallest of the three new R-Series Camo Recliner Chairs
- High-density foam mattress with Micro Fleece
- Extra padding in top section of back for added comfort
- Four fully-adjustable legs with large swivelling mud feet
- Fox Camo polyester outer trim
- Leg Lock frame for added stability
- Adjustable back settings via Cam wheel
- Hard-wearing steel frame
- Main outer fabric: 100% Polyester
Padding/Filling: 100% Polyurethane

*RRP

CBC060 R1 Camo Chair £94.99

Height: 39-47cm
Seat width: 59cm
Back height: 57cm
Folded: 75x70x20cm



7.00kg

R2 CAMO RECLINER CHAIR

- High-density foam mattress with Micro Fleece
- Extra padding in top section of back for added comfort
- Four fully-adjustable legs with large swivelling mud feet
- Fox Camo polyester outer trim
- Leg Lock frame for added stability
- Adjustable back settings via Cam wheel
- Hard-wearing steel frame
- Neoprene covered arm rests for added comfort
- Main outer fabric: 100% Polyester
Padding/Filling: 100% Polyurethane

*RRP

CBC061 R2 Camo Chair £109.99

Height: 44-56cm
Seat width: 60cm
Back height: 73cm
Folded: 84x70x20cm



7.50kg

R3 CAMO RECLINER CHAIR

- Largest of the three new R-Series Camo Recliner Chairs
- Fox Camo polyester outer trim
- High-density foam mattress with Micro Fleece
- Four fully-adjustable legs with large swivelling mud feet
- Leg Lock frame for added stability
- Adjustable back settings via Cam wheel
- Hard-wearing steel frame
- Neoprene covered arm rests for added comfort
- Full height back with additional padding in the head rest
- Main outer fabric: 100% Polyester
Padding/Filling: 100% Polyurethane

*RRP

CBC062 R3 Camo Chair £139.99

Height: 40cm
Seat depth: 38cm
Seat width: 48cm
Back height: 53cm



4.80kg

WARRIOR® II COMPACT CHAIR

- Compact design
- Natural green colours
- Comfortable armrests
- Padded cover
- Easily foldable
- Adjustable front legs
- Main outer fabric: 100% Polyester
Padding/Filling: 100% Polyurethane

*RRP

CBC067 Warrior II Compact Chair £59.99

Height: 40-50cm
Seat depth: 41cm
Seat width: 49cm
Back height: 64cm



5.40kg

WARRIOR® II ARM CHAIR

- All four legs are fully adjustable
- Natural green colours
- Comfortable armrests
- Padded cover
- Easily foldable
- Main outer fabric: 100% Polyester
Padding/Filling: 100% Polyurethane

*RRP

CBC068 Warrior II Arm Chair £69.99

Height: 40-51cm
Seat depth: 41cm
Seat width: 53cm
Back height: 64cm



5.70kg

WARRIOR® II XL ARM CHAIR

- Natural green colours
- Comfortable armrests
- Padded cover
- Easily foldable
- All four legs are fully adjustable
- Main outer fabric: 100% Polyester
Padding/Filling: 100% Polyurethane

*RRP

CBC069 Warrior II XL Arm Chair £84.99

Height: 32cm
Seat width: 47cm
Back height: 52cm
Folded: 14x54x72cm



5.50kg

FX COMBO CHAIR

- Multi-purpose, innovative design that makes it one of the most versatile and comfortable chairs on the market
- Three uses in one!
- Use 1: Positioned across bedchair like a traditional bedchair buddy
- Use 2: Positioned on side of bedchair frame for sitting at front of bivvy
- Use 3: Independent of a bedchair as a standalone low chair
- Adjustable back leg
- Fully adjustable 'Twist Lok' front legs
- Same fleece-lined, high-density foam padding as used on award-winning FX Flatliner bedchairs
- Padded head rest for extra comfort
- Retaining straps keep chair closed when being carried
- Removable, padded shoulder strap supplied for easy transportation
- Main outer fabric: 100% Polyester,
Padding/Filling: 100% Polyurethane

*RRP

CBC042 FX Combo Chair £94.99

Height: 45-60cm
Seat width: 60cm
Back height: 70cm
Folded: 21x71x83cm



10.95kg

FX SUPER DELUXE RECLINER

- Quite possibly the most comfortable and feature-filled chair ever designed for fishing
- Full height back featuring unique deluxe head support for ultimate comfort
- Cam Lok recliner allowing you to set the seating position that best suits your mood
- High-density ribbed foam mattress with micro fleece
- Fabric inner and luxury faux suede perimeter as used on Flatliner bedchair and FX Combo Chair
- Neoprene-covered arm rests for extra comfort
- Four adjustable 'Twist Lok' legs with swivelling mud feet to allow ultimate comfort when on uneven ground
- Steel frame for strong build quality and to accommodate the 'larger' angler
- Main outer fabric: 100% Polyester,
Padding/Filling: 100% Polyurethane

*RRP

CBC047 FX Super Deluxe Recliner £169.99



Chair not included

WATERPROOF CHAIR COVERS

- Waterproof cover designed to keep your chair dry when left outside bivvy in rain/heavy dew
- 2000mm hydrostatic head
- Fully-taped seams
- Khaki colour
- Elasticated for secure fit
- Supplied with carry bag
- Two sizes available: Standard to fit small/medium chairs and XL for larger recliner-style chairs

*RRP

CBC063 Standard Chair Cover £14.99
CBC064 XL Chair Cover £15.99



VRS SLEEPING BAG

- Based on original Evo Ven-Tec All Season sleeping bag, but with significant upgrades
- Features top-quality waterproof Ven-Tec Rip Stop outer fabric
- Utilises 7 Core Hollow Fibre filling, which is silicone-treated to help maintain shape, and expand fibres
- Comprises a total of four layers for unrivalled warmth even in the coldest of conditions
- Contains a removable thermal booster bag, which is microfleece lined on all sides and packed with 7 core hollow fibre fill
- Base and upper layer also packed with top quality 7 core hollow fibre fill
- Polyester-lined base layer
- Microfleece lining gives incredible warmth and comfort
- Offset panel stitching helps to keep warm air inside the bag
- 10mm heavy-duty crash zips that don't snag when you need to exit the bag in a hurry
- Oversized external zip baffles help to keep cold air out and warm air in
- Oversized internal baffles packed with Hollofil to keep warm air in bag prevent it escaping through zips
- Elasticated hoods at head and foot end plus elasticated strap in middle to help secure bag to bedchair
- Zipped mesh pockets on both sides are perfect for storing valuable items such as receiver, keys, phone and wallet
- Pillow-retaining hood helps to stop your pillow from sliding off the bed
- Hot foot pocket – zips stop short at the foot end to create a thermal pocket around your feet
- Supplied in stuff sack
- Main outer fabric: 100% Polyester
Padding/Filling: 100% Polyester

		*RRP
CSB037	VRS1 Sleeping Bag	£189.99
CSB038	VRS2 Sleeping Bag	£199.99
CSB039	VRS3 Sleeping Bag	£219.99

VRS 1: 88cm x 210cm
Stuff sack: 40 x 51cm
6.00kg

VRS 2: 93cm x 213cm
Stuff sack: 45 x 51cm
6.60kg

VRS 3: 103cm x 220cm
Stuff sack: 50 x 54cm
7.40kg

NEW

VRS CAMO SLEEPING BAG COVER



- Styled in Fox Camo
- Waterproof Ventec Ripstop fabric
- 20,000mm hydrostatic head
- Microfleece lined
- Velcro retaining side strips
- Snug fit drawcord
- D-loop sleeping bag attachment
- Ideal for adding to ERS sleeping bag to give a waterproof cover and additional warmth

		*RRP
CSB057	VRS1 Camo Sleeping Bag Cover	£59.99
CSB058	VRS2 Camo Sleeping Bag Cover	£69.99
CSB059	VRS3 Camo Sleeping Bag Cover	£79.99

VRS 1: 140cm x 234cm
Stuff sack: 38 x 20cm
1.40kg

VRS 2: 150cm x 240cm
Stuff sack: 40 x 20cm
1.50kg

VRS 3: 160cm x 250cm
Stuff sack: 42 x 20cm
1.60kg

NEW

VRS CAMO THERMAL



- Styled in Fox Camo
- Waterproof Ventec Ripstop fabric
- 20,000mm hydrostatic head
- Microfleece lined
- Velcro retaining side strips
- Snug fit drawcord
- D-loop sleeping bag attachment
- Ideal for adding to a sleeping bag to convert to a 5-season bag for the coldest conditions

		*RRP
CSB060	VRS1 Thermal Sleeping Bag Cover	£79.99
CSB061	VRS2 Thermal Sleeping Bag Cover	£89.99
CSB062	VRS3 Thermal Sleeping Bag Cover	£99.99

VRS 1: 140cm x 234cm
Stuff sack: 44 x 36cm
2.70kg

VRS 2: 150cm x 240cm
Stuff sack: 46 x 36cm
3.00kg

VRS 3: 160cm x 250cm
Stuff sack: 48 x 36cm
3.30kg



ERS SLEEPING BAG STANDARD

- Features market-leading hardwearing Evo-Tec Rip Stop outer fabric
- Utilises 7 Core Hollow Fibre filling which is silicone-treated to help maintain shape and expand fibres
- Polyester lined base for ease of movement inside the bag
- Microfleece lined upper layer for added warmth and comfort
- Offset panel stitching helps to keep warm air inside the bag
- 10mm heavy-duty crash zips that don't snag when you need to exit the bag in a hurry
- Oversized external zip baffles help to keep cold air out and warm air in
- Oversized internal baffles packed with Hollofil to keep warm air in bag prevent it escaping through zips
- Elasticated hoods at head and foot end plus elasticated strap in middle to help secure bag to bedchair
- Zipped mesh pockets on both sides are perfect for storing valuable items such as receiver, keys, phone and wallet
- Pillow-retaining hood helps to stop your pillow from sliding off the bed
- Hot foot pocket – zips stop short at the foot end to create a thermal pocket around your feet
- Supplied in stuff-sack
- Main outer fabric: 100% Polyester
Padding/Filling: 100% Polyester, Lining: 100% Polyester

		*RRP
CSB034	ERS1 Sleeping Bag	£94.99
CSB035	ERS2 Sleeping Bag	£104.99
CSB036	ERS3 Sleeping Bag	£109.99

ERS 1: 88cm x 210cm
Stuff sack: 33 x 44cm
2.80kg

ERS 2: 93cm x 213cm
Stuff sack: 34 x 45cm
3.00kg

ERS 3: 103cm x 220cm
Stuff sack: 35 x 50cm
3.50kg

ERS SLEEPING BAG FULL FLEECE

- Based on same design as original ERS sleeping bags but with full fleece inner lining for added warmth and comfort
- Sherpa fleece-lined internal upper layer
- Microfleece-lined internal base layer
- Features market-leading hardwearing Evo-Tec Rip Stop outer fabric
- Utilises 7 Core Hollow Fibre filling which is silicone treated to help maintain shape and expand fibres
- Polyester-lined base for ease of movement inside the bag
- Microfleece lined upper layer for added warmth and comfort
- Offset panel stitching helps to keep warm air inside the bag
- 10mm heavy-duty crash zips that don't snag when you need to exit the bag in a hurry
- Oversized external zip baffles help to keep cold air out and warm air in
- Oversized internal baffles packed with hollow fill to keep warm air in bag prevent it escaping through zips
- Elasticated hoods at head and foot end plus elasticated strap in middle to help secure bag to bedchair
- Zipped mesh pockets on both sides are perfect for storing valuable items such as receiver, keys, phone and wallet
- Pillow-retaining hood helps to stop your pillow from sliding off the bed
- Hot foot pocket – zips stop short at the foot end to create a thermal pocket around your feet
- Supplied in stuff-sack
- Main outer fabric: 100% Polyester
Padding/Filling: 100% Polyester, Lining: 100% Polyester

		*RRP
CSB049	ERS1 Full Fleece Sleeping Bag	£104.99
CSB050	ERS2 Full Fleece Sleeping Bag	£114.99
CSB051	ERS3 Full Fleece Sleeping Bag	£124.99

ERS 1: 88cm x 210cm
Stuff sack: 37 x 48cm
3.30kg

ERS 2: 93cm x 213cm
Stuff sack: 40 x 48cm
3.50kg

ERS 3: 103cm x 220cm
Stuff sack: 43 x 50cm
4.20kg



WARRIOR® SLEEPING BAG STANDARD & XL

- Designed for newcomers and anglers on a tight budget that still want Fox quality
- Perfect for use with the Warrior bedchair
- Offset panel stitching helps to keep warm air inside the bag
- 2-3 season rating - perfect for use in late spring, summer and early autumn
- 10mm crash zips
- Soft Touch Polyester fabric
- Polyester lining for easy movement inside the bag
- Oversized internal and external baffles to keep warm air in and cold air out
- Elasticated hoods at head and foot end plus elasticated strap in middle to help secure bag to bedchair
- Comes supplied in stuff-sack
- Offers outstanding value for money
- Main outer fabric: 100% Polyester
Padding/Filling: 100% Polyester
Lining: 100% Polyester

		*RRP
CSB043	Warrior Sleeping Bag	£59.99
CSB052	Warrior XL Sleeping Bag	NEW £69.99

WARRIOR: 88cm x 210cm
Stuff sack: 40 x 50cm
2.40kg

WARRIOR XL: 103cm x 210cm
Stuff sack: 36 x 55cm
2.65kg



LUGGAGE & BARROWS

Last year saw us launch a brand new, top-end range of luggage under the Voyager banner and over the past twelve months this has become incredibly popular. Due to the quality of the range, it carries with it, prices that not all anglers can afford or justify. We felt it appropriate therefore, to design and launch a new, lower-cost range for 2019. Our team of product designers chose to discontinue the long-standing Royale range and replace it with the improved R-Series. It's fair to say that the team have excelled themselves. They've not only managed to better the Royale luggage, but have achieved, on average, a 20% price reduction across the new range!

In addition to the new R-Series and Voyager luggage, you'll also find our market-leading Camolite range in this section, which continues to grow in popularity year on year. Fans of Camolite will be pleased to see the new additions. We also have some great neoprene luggage items in our Fox Camo pattern for you!

This section not only covers luggage, but also showcases our impressive range of barrows. Our product development team understand just how important it is to be able to transport tackle to and from your swim with comfort and ease. They also appreciate how crucial mobility is and have worked on designs to enable anglers to fish 'off the barrow'.

NEW



R-SERIES COMMON FEATURES

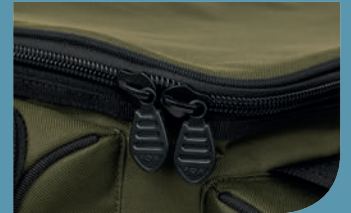

- Hard-wearing and water-resistant 400 denier treated polyester fabric
- Heavy-duty buckles and clips
- Stiffened EVA grab handles
- Heavy-duty double zips
- Reinforced bases where needed

FOX  CAMOLITE



CAMOLITE™ COMMON FEATURES



- 100%-treated 500 denier polyester material
- Heavy-duty buckles and clips
- Stiffened EVA grab handles
- Heavy-duty double zips
- Reinforced bases where needed

FOX  VOYAGER



VOYAGER® COMMON FEATURES



- Hydratec water-resistant fabric (100%-treated 1050 denier polyester)
- Heavy-duty buckles and clips
- Stiffened EVA grab handles
- Heavy-duty double zips
- Reinforced bases where needed

NEW



R-SERIES ROD HOLDALLS

- New hard-wearing and water-resistant 400 denier treated polyester fabric
- Fully padded with large, central divider to fully protect your rods
- Designed to accommodate rods with 50mm butt rings and bit pit reels
- 12ft 3 Rod - will house three 12ft rods with reels on plus a further three 12ft rods without reels
- 13ft 4 Rod - will house four 13ft rods with reels on plus a further four 13ft rods without reels
- Aluminium spine-stiffener
- Velcro rod fasteners are perfectly sized with ergonomically-designed rubber tab ends for ease of use
- Heavy-duty double 10mm zips ensure complete reliability
- Removable, padded shoulder strap
- Two external pockets - one for banksticks, one for storm pole and landing net etc
- Main outer fabric: 100% Polyester, Padding/filling: 70% Polyethylene 30% Polyurethane, Lining: 100% Polyester
- 12ft 3 Rod dimensions: 196cm x 31cm
- 13ft 4 Rod dimensions: 210cm x 39cm

*RRP

CLU362	12ft 3 Rod Holdall	£79.99
CLU363	13ft 4 Rod Holdall	£89.99



R-SERIES 12FT TRI-SLEEVE

- New hard-wearing and water-resistant 400 denier treated polyester fabric
- Will house three 12ft rods with reels on
- Designed to accommodate rods with 50mm butt rings and bit pit reels
- Stiffened EVA grab handles
- External pocket for landing net storage
- Reversible, padded shoulder strap
- Heavy-duty double 10mm zips ensure complete reliability
- Main outer fabric: 100% Polyester, Padding/filling: 40% Polyurethane/ 60% Polyethylene, Lining: 100% Polyester
- Dimensions: 192cm x 36cm x 30cm

*RRP

CLU361	Tri Sleeve 12ft	£59.99
--------	-----------------	--------



R-SERIES 2 ROD SLEEVE

- New hard-wearing and water-resistant 400 denier treated polyester fabric
- Will house two rods with reels on
- Designed to accommodate rods with 50mm butt rings and bit pit reels
- Ideal for anglers who only use two rods
- Perfect for storing spod and marker rods
- External pocket for landing net storage
- Reversible, padded shoulder strap
- Heavy-duty double 10mm zips ensure complete reliability
- 10ft and 12ft models available
- Main outer fabric: 100% Polyester, Padding/filling: 40% Polyurethane/ 60% Polyethylene, Lining: 100% Polyester
- Dimensions: 10ft: 165cm x 26cm x 26cm, 12ft: 192cm x 34cm x 26cm

*RRP

CLU359	2 Rod Sleeve 10ft	£49.99
CLU360	2 Rod Sleeve 12ft	£54.99



FEATURES



2 Rod Sleeve



3 Rod Holdall



Single Rod Sleeve



Reinforced base on Tri and 2-Rod Sleeves



External pocket for landing net storage

R-SERIES QUIVER & 3 SLEEVES

- New hard-wearing and water-resistant 400 denier treated polyester fabric
- Supplied with 3x 12ft Single Rod Jackets, which offer padded protection to your rods and reels
- Internal compartment will hold a 60ins broly or broly system
- Capacity to hold 5 Rod Sleeves
- Double zipped for ease of access
- Removable strap for use on barrows
- Three external pockets to house net pole, banksticks, landing net and storm poles
- Compression straps hold rod sleeves securely
- All sleeves can be secured by clips individually
- Heavy-duty double 10mm zips ensure complete reliability
- Main outer fabric: 100% Polyester, Padding/filling: 5% Polyethylene 95% Polyurethane, Lining: 100% Polyester
- Dimensions: 198cm x 24cm

R-SERIES SINGLE SLEEVE

- New hard-wearing and water-resistant 400 denier treated polyester fabric
- Available in 10, 12 and 13ft options
- Specially-sculpted profile to accept 50mm butt rings
- Two stiffened EVA grab handles
- Heavy-duty double 10mm zips ensure complete reliability
- Reel-forward design with double zips up the rod spine to protect your line
- Top 15 cm of the jacket is not zipped so your rod is held in situ when you zip up the jacket – no more fiddling!
- Reel section gusseted to accommodate all big pit models
- Hanging loop at top
- Main outer fabric: 100% Polyester, Padding/filling: 100% Polyurethane, Lining: 100% Polyester
- Dimensions: 10ft: 165cm x 24cm, 12ft: 192cm x 24cm, 13ft: 210cm x 24cm

*RRP

CLU364 5 Rod Quiver & 3 Sleeves 12ft £119.99

*RRP

CLU356 Single Sleeve 10ft £19.99
 CLU357 Single Sleeve 12ft £23.99
 CLU358 Single Sleeve 13ft £25.99

NEW

R-SERIES CARRYALL MEDIUM

- New hard-wearing and water-resistant 400 denier treated polyester fabric
- Heavy-duty double 10mm zips ensure complete reliability
- 56l capacity
- Perfect for storing multitude of tackle items
- Removable shoulder strap
- Reinforced EVA grab handles
- Three external pockets:
Front pocket holds a large Single F Box
Two side pockets house either one large or two medium accessory bags
- Main outer fabric: 100% Polyester, Padding/filling: 100% Polyethylene, Lining: 100% Polyester
- Dimensions: 50cm x 30cm x 30cm



CLU365 Carryall Medium *RRP
£39.99

R-SERIES CARRYALL LARGE

- New hard-wearing and water-resistant 400 denier treated polyester fabric
- Heavy-duty double 10mm zips ensure complete reliability
- 80l capacity
- Perfect for storing multitude of tackle items
- Removable shoulder strap
- Reinforced EVA grab handles
- Three external pockets:
Front pocket houses a large Double F Box and a medium accessory bag
Two side pockets each hold one large and one medium accessory bag
- Main outer fabric: 100% Polyester, Padding/filling: 100% Polyethylene, Lining: 100% Polyester
- Dimensions: 61cm x 39cm x 30cm



CLU366 Carryall Large *RRP
£49.99

R-SERIES CARRYALL XL

- New hard-wearing and water-resistant 400 denier treated polyester fabric
- Heavy-duty double 10mm zips ensure complete reliability
- 128l capacity
- Perfect for storing multitude of tackle items
- Removable shoulder strap
- Reinforced EVA grab handles
- Six external pockets:
 - Front pocket holds a large, Double F Box and two accessory bags
 - Two rear pockets each hold a large, Double F Box
 - Large side pocket holds a large, Single F Box
 - Small side pockets are stepped to allow easy access; the smaller houses two small accessory bags, the larger a medium accessory bag
- Main outer fabric 100% Polyester, Padding/Filling 100% Polyethylene, Lining 100% Polyester
- Dimensions 76cm x 44cm x 37cm



CLU367 Carryall XL *RRP
£59.99



NEW



BARROW BAG FEATURES



Front pockets hold tackle box



Stiffened EVA grab handles

R-SERIES BARROW BAGS STANDARD & XL

- New hard-wearing and water-resistant 400 denier treated polyester fabric
- Heavy-duty double 10mm zips ensure complete reliability
- Moulded base and lid
- Perfect for storing multitude of tackle items
- 2x external side pockets for storing tackle essentials
- Standard - 1x external central pocket for tackle box storage
- XL - 2x external front pockets for tackle box and additional storage
- Stiffened EVA grab handles
- Removable, padded shoulder strap
- Main outer fabric: 100% Polyester, Padding/filling: 100% Polyethylene, Lining: 100% Polyester, Base: 100% Ethylene Vinyl Acetate Copo (EVA)
- Standard - Dimensions: 60cm x 38cm x 44cm
- XL - Dimensions: 82cm x 36cm x 44cm

		*RRP
CLU368	Barrow Bag Standard	£69.99
CLU369	Barrow bag XL	£89.99

R-SERIES RUCKSACK

- New hard-wearing and water-resistant 400 denier treated polyester fabric
- Heavy-duty double 10mm zips ensure complete reliability
- 35-litre inner compartment
- Perfect for the mobile or roving angler
- Front pocket fits Large F-Box tackle box
- Top pocket for accessories
- Two small side pockets for accessories
- Elasticated loops for holding banksticks
- Stiffened EVA grab handle
- Fully adjustable shoulder harness and waist strap
- Wipe clean, hard-wearing base
- Retaining straps for securing unhooking mat or lightweight chair
- Main outer fabric: 100% Polyester, Padding/filling: 80% Polyethylene 20% Polyurethane, Lining: 100% Polyester
- Main compartment dimensions: 35cm x 35cm x 22cm



		*RRP
CLU370	Rucksack	£49.99

NEW



R-SERIES 2 MAN FOOD COOLER BAG

- New hard-wearing and water-resistant 400 denier treated polyester fabric
- Heavy-duty double 10mm zips ensure complete reliability
- Central, thermally-insulated and easy clean main compartment with a 60:40 divider for compartmentalised food storage
- Two large padded and double-zipped external pockets for your stove, canned food and accessories
- Large front pocket opens into a fold out utensil store containing: 2x stainless steel knives, forks, spoons and teaspoons, 2x round green plates, 2x green mugs, 1x corkscrew, 1x large screw top tubs, 2x small screw top tubs, 1x microfleece towel
- Internal recessed storage area for oil, ketchup and sauces, washing up liquid etc
- Adjustable and removable shoulder strap
- Main outer fabric: 100% Polyester, Padding/filling: 100% Polyethylene, Lining: 100% Polyester
- Dimensions: 55cm x 41cm x 38cm

*RRP

CLU371	2 Man Food Cooler Bag	£89.99
--------	-----------------------	--------

R-SERIES 2 MAN DINNER SET

- New hard-wearing and water-resistant 400 denier treated polyester fabric
- Heavy-duty double 10mm zips ensure complete reliability
- Stiffened EVA handles
- Supplied with: 2x stainless steel knives, forks, spoons and teaspoons, 2x round green plates, 2x green mugs, 1x Corkscrew, 1x large screw top tubs, 2x small screw top tubs, 1x microfleece towel
- Main outer fabric: 100% Polyester, Padding/filling: 100% Polyethylene, Lining: 100% Polyester
- Dimensions: 28cm x 12cm x 28cm



*RRP

CLU374	2 Man Dinner Set	£39.99
--------	------------------	--------



R-SERIES COOLER BAG STANDARD & LARGE

- New hard-wearing and water-resistant 400 denier treated polyester fabric
- Heavy-duty double 10mm zips ensure complete reliability
- Thermally-insulated, wipe-clean lining
- Perfect for session storage of bait, food or drinks
- Stiffened EVA handles
- Main outer fabric: 100% Polyester, Padding/filling: 100% Polyethylene, Lining: 100% Polyethylene Terephthalate
- Standard - Dimensions: 27cm x 25cm x 25.5cm
- Large - Dimensions: 37.5cm x 29cm x 25.5cm

*RRP

CLU372	Cooler Bag Large	£29.99
CLU373	Cooler Bag Standard	£19.99

NEW



Contents not included

R-SERIES BEDCHAIR BAG

- New hard-wearing and water-resistant 400 denier treated polyester fabric
- Heavy-duty double 10mm zips ensure complete reliability
- Stiffened EVA handles
- Removable shoulder strap
- Perfect for storing R1, R2, Warrior 2, Flatliner and Flatlitter MK2 bedchairs
- Fits most other makes of standard-sized bedchair on the market
- Sized to allow space for a light sleeping bag and pillow
- Main outer fabric: 100% Polyester, Padding/filling: 100% Polyethylene, Lining: 100% Polyester
- Dimensions: 86cm x 25cm x 86cm

		*RRP
CLU375	Bedchair Bag	£39.99



Contents not included

R-SERIES BUZZ BAR BAG

- New hard-wearing and water-resistant 400 denier treated polyester fabric
- Heavy-duty double 10mm zips ensure complete reliability
- Designed to store 3-rod buzz bars with alarms and back rests in place
- Well-padded bags to give ultimate protection to alarms and buzz bars
- Zipped mesh pocket to house hangers, small indicators plus a Black Label Compact Pod
- Velcro loops secure all buzz bars and prevent movement during transport
- Main outer fabric: 100% Polyester, Padding/filling: 100% Polyethylene, Lining: 100% Polyester
- Dimensions: 51cm x 6cm x 23cm

		*RRP
CLU382	Buzz Bar Bag	£17.99



Contents not included

R-SERIES OUTBOARD MOTOR BAG

- New hard-wearing and water-resistant 400 denier treated polyester fabric
- Designed to store and transport electric outboard motors
- Will house all Fox FX Pro models
- Internal Velcro retaining strap to hold engine in place
- Heavy-duty double 10mm zips ensure complete reliability
- Two reinforced plastic handles on top of bag for easy carrying in and out of your vehicle
- Side carry handle
- Main outer fabric: 100% Polyester, Padding/filling: 100% Polyethylene, Lining: 100% Polyester
- Dimensions: 120cm x 47cm

		*RRP
CLU376	Outboard Motor Bag	£39.99



Contents not included

R-SERIES REEL CASE

- New hard-wearing and water-resistant 400 denier treated polyester fabric
- Heavy-duty double 10mm zips ensure complete reliability
- Stiffened to give ultimate protection
- Designed to accommodate reels of all sizes including big pit models
- Main outer fabric: 100% Polyester, Padding/filling: 100% Polyethylene, Lining: 100% Polyester
- Dimensions: 24cm x 10.5cm x 18cm

		*RRP
CLU384	Reel Case	£9.99

NEW



Contents not included

R-SERIES ACCESSORY BAG SMALL

- New hard-wearing and water-resistant 400 denier treated polyester fabric
- Heavy-duty double 10mm zips ensure complete reliability
- Ideal for storing rig essentials and other items such as head torch
- Designed to fit into the exterior pockets of the R-Series Rucksack, Carryalls and Barrow Bags
- Main outer fabric: 100% Polyester, Padding/filling: 100% Polyethylene, Lining: 100% Polyester
- Dimensions: 16cm x 8cm x 10cm

*RRP

CLU377 Accessory Bag Small £9.99



Contents not included

R-SERIES ACCESSORY BAG MEDIUM

- New hard-wearing and water-resistant 400 denier treated polyester fabric
- Heavy-duty double 10mm zips ensure complete reliability
- Ideal for storing rig essentials, Impact Spods plus a host of other items
- Designed to fit into the exterior pockets of the Royale Rucksack, Carryalls and Bait Bag
- Zipped mesh pocket in lid
- Main outer fabric: 100% Polyester, Padding/filling: 100% Polyethylene, Lining: 100% Polyester
- Dimensions: 22cm x 8cm x 13cm

*RRP

CLU378 Accessory Bag Medium £10.99



Contents not included

R-SERIES ACCESSORY BAG LARGE

- New hard-wearing and water-resistant 400 denier treated polyester fabric
- Heavy-duty double 10mm zips ensure complete reliability
- Ideal for storing rig essentials, marker floats, PVA dispensers plus other items
- Designed to fit into the exterior pockets of the Royale Rucksack, Carryalls and Bait Bag
- Zipped mesh pocket in lid
- Stiffened EVA grab handle
- Main outer fabric: 100% Polyester, Padding/filling: 100% Polyethylene, Lining: 100% Polyester
- Dimensions: 26.5cm x 8cm x 17cm

*RRP

CLU379 Accessory Bag Large £13.99



Contents not included

R-SERIES LEAD & BITS BAG

- New hard-wearing and water-resistant 400 denier treated polyester fabric
- Heavy-duty double 10mm zips ensure complete reliability
- Versatile storage for leads, Method feeders and similar items
- Stiffened EVA grab handle on top
- Zipped mesh accessory pocket
- Two stiffened inserts with Velcro fastening for you to customise to your own requirements
- Main outer fabric: 100% Polyester, Padding/filling: 100% Polyethylene, Lining: 100% Polyester
- Dimensions: 22cm x 8cm x 14cm

*RRP

CLU380 Lead & Bits Bag £14.99



Contents not included

R-SERIES HOOKBAITS BAG

- New hard-wearing and water-resistant 400 denier treated polyester fabric
- Heavy-duty double 10mm zips ensure complete reliability
- Supplied with eight moulded watertight screw top hookbait tubs (4x large and 4x small)
- Designed for storage of hookbaits, dips and liquids
- Stiffened EVA grab handle on top
- Tinted PVC lid
- Main outer fabric: 100% Polyester, Lid: 100% Polyvinyl Chloride (PVC), Padding/filling: 100% Polyethylene, Lining: 100% Polyester
- Dimensions: 25cm x 12cm x 16cm

*RRP

CLU381 Hookbaits Bag & Pots £19.99



Contents not included

R-SERIES SPOOL CASE

- New hard-wearing and water-resistant 400 denier treated polyester fabric
- Heavy-duty double 10mm zips ensure complete reliability
- Designed to keep your spare spools in top condition when not in use
- Supplied with two foam dividers
- Will house big pit spools including spools for FX13 reel
- Double zip with webbing bridge for ease of access
- Stiffened for extra protection
- Main outer fabric: 100% Polyester, Padding/filling: 30% Polyethylene 70% Polyurethane, Lining: 100% Polyvinyl Chloride (PVC)

*RRP

CLU383 Spool Case £10.99

FOX CAMOLITE



CAMOLITE™ 3 UP 2 DOWN ROD HOLDALL

- Based on same award-winning design from FX luggage range
- Takes five made-up rods in total – three in one direction and two in the other
- Sculpted to accommodate big pit reels and 50mm butt rings
- Padded internal dividers
- External storage pockets for leads and rig bits
- Reinforced base
- 10mm heavy-duty double zips
- Stiffened EVA grab handles
- Reversible, padded shoulder strap
- 100%-treated 500 denier polyester material
- Styled in unique Fox Camo pattern
- Main outer fabric: 100% Polyester
Lining: 100% Polyester
Padding/Filling: 70% Polyethylene 30% Polyurethane
- Dimensions: H 198cm x W 40cm x D 30cm

*RRP

CLU288 Camolite 3 up 2 Down 12ft £149.99

CAMOLITE™ TRI-SLEEVE

- Available in three sizes: 10ft, 12ft and new 13ft option
- Designed to store three made-up rods
- Sculpted to accommodate big pit reels and 50mm butt rings
- Padded internal dividers
- Reinforced base
- External storage pockets for leads and rig bits
- 10mm heavy-duty double zips
- Stiffened EVA grab handles
- Reversible, padded shoulder strap
- 100%-treated 500 denier polyester material
- Styled in unique Fox Camo pattern
- Main outer fabric: 100% Polyester
Lining: 100% Polyester
Padding/Filling: 60% Polyethylene and 40% Polyurethane
- Dimensions:
10ft: H 165cm x W 38cm x D 30cm
12ft: H 192cm x W 38cm x D 30cm
13ft: H 208cm x W 38cm x D 30cm

*RRP

CLU286 Camolite Tri-Sleeve 10ft £99.99

CLU287 Camolite Tri-Sleeve 12ft £119.99

CLU297 Camolite Tri-Sleeve 13ft £134.99

FEATURES



Handy storage pockets on Rod Holdall and Tri Sleeve



Stiffened EVA grab handles



Reversible shoulder straps

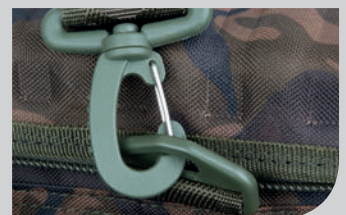

Top quality buckles and clips



CAMOLITE™ XL TIP PROTECTOR

- Unique Fox Camo pattern
- Solid end to protect rod tips
- Top 8cm contains reinforced padding
- Velcro securing strap fits under the butt eye
- Extra-long to accommodate most butt eye positioning
- 100%-treated 500 denier polyester

*RRP

CLU309 Camolite XL Tip Protector £9.99



CAMOLITE™ SINGLE ROD JACKETS

- Available in 10ft, 12ft and 13ft
- Designed to store one made-up rod
- Sculpted to accommodate big pit reels and 50mm butt rings
- 10mm heavy-duty double zips
- Stiffened EVA grab handles
- 100%-treated 500 denier polyester material
- Styled in unique Fox Camo pattern
- Main outer fabric: 100% Polyester
Lining: 100% Polyester
Padding/Filling: 100% Polyurethane
- Dimensions:
10ft: H 168cm x W 24cm
12ft: H 198cm x W 24cm
13ft: H 210cm x W 24cm

		*RRP
CLU290	Camolite Single Rod Jacket 10ft	£34.99
CLU291	Camolite Single Rod Jacket 12ft	£35.99
CLU292	Camolite Single Rod Jacket 13ft	£37.99



CAMOLITE™ BROLLY CARRYALL

- Ideal for use with Royale and Ultra 60 brolly ranges
- Camolite Tri Sleeve, 3 Up 2 Down or Single Jackets can fit in outside pocket and strap to outside of carryall
- Moulded base and top
- 10mm heavy-duty double zips
- Stiffened EVA grab handles
- Reversible, padded shoulder strap
- 100%-treated 500 denier polyester material
- Styled in unique Fox Camo pattern
- Main outer fabric: 100% Polyester
Lining: 100% Polyester
Padding/Filling: 100% Polyethylene
Base: 100% Ethylene Vinyl Acetate Copo (EVA)
- Dimensions: H 178cm x W 22cm x D 25cm

		*RRP
CLU289	Camolite Brolly Carryall	£59.99



CAMOLITE™ ROD & REEL PROTECTOR

- Unique Fox Camo pattern
- Quilted padding to protect your reels in transit
- Rod-tip protectors are joined by heavy-duty elastic to fit all rods from 10ft to 13ft
- Zipped lead pocket
- 100%-treated 500 denier polyester

Rod not included

		*RRP
CLU320	Rod & Reel Protector	£21.99



CAMOLITE™ LARGE SPOOL CASE

- Unique Fox Camo pattern
- Stiffened along entire length for full crush protection
- Double zip with webbing bridge for ease of opening
- Wipe-clean liner to keep grit and debris out of your spools
- Supplied with three foam dividers
- Holds four big pit spools
- 100%-treated 500 denier polyester

		*RRP
CLU308	Camo Large Spool Case	£16.99



CAMOLITE™ 17LTR & 10LTR BUCKET CARRYALLS

- Designed to work with 10L or 17L Fox Camo Bucket (available to purchase separately, see below)
- Bucket simply slides into central section to create a unique carryall
- Perfect for the mobile angler that likes to go stalking, surface fishing etc.
- Two external side pockets for storing essential accessories – one of which is insulated making it ideal for keeping food or bait fresh
- Front pocket accommodates a large Fox tackle box
- Elasticated loop for storage of catapult or throwing stick
- Padded, wipe clean flap that creates a seat
- Padded, removable shoulder strap
- High quality heavy-duty double zips
- 100%-treated 500 denier polyester material
- Styled in unique Fox Camo pattern
- Main outer fabric: 100% Polyester
Lining: 100% Polyester
Padding/Filling: 100% Polyurethane
Base: 100% (PVC) Polyvinyl chloride
- 10L Dimensions: 37cm x 32cm x 24cm
- 17L Dimensions: 39cm x 32cm x 31cm

		*RRP
CLU305	Camolite 10L Bucket Carryall	£39.99
CLU306	Camolite 17L Bucket Carryall	£44.99

CAMOLITE™ 5LTR, 10LTR & 17LTR SQUARE BUCKETS

- Available in 5L, 10L and 17L
- Perfect for spod mixes, maggots and groundbaits
- Square design makes them much more barrow-friendly than a more conventional round bucket
- Easier to stack and also easier to store in your car
- Extra strong metal handle

		*RRP
CBT005	Camo Square Bucket 5L	£5.99
CBT006	Camo Square Bucket 10L	£7.99
CBT007	Camo Square Bucket 17L	£9.99

NEW

CAMOLITE™ BAIT DRY BAG MEDIUM & LARGE

- Dual-purpose bait bag
- Integrated 'drop down' air-dry mesh released by single zip
- Medium - Designed to fit in the front mesh pockets of all Explorer barrow models
- Perfect for air-drying boilies when on longer sessions
- Polyester carry handles with Heavy-duty clips
- Unique Fox Camo print
- Heavy-duty double zips
- 100%-treated polyester 500 denier
- Medium Dimensions: 25cm x 20cm x 14.5cm
- Large Dimensions: 36cm x 32cm x 29cm



		*RRP
CLU387	Bait Dry Bag Medium	£18.99
CLU388	Bait Dry Bag Large	£23.99

Contents not included

FEATURES



'Drop down' air dry mesh



Medium works with Explorer Barrow

FOX CAMOLITE

CAMOLITE™ BOILIE BUM BAGS STANDARD & LARGE

- Unique Fox Camo pattern
- Double heavy-duty zips
- Mesh fabric allows bag to double up as an air dry bag
- Elasticated belt loop for holding catapult/throwing stick
- Adjustable waist strap can also be used to hang on branches etc.
- 100%-treated 500 denier polyester
- Two sizes available: Standard (holds 2.5kg approx.) and Large (holds 6kg approx.)



		*RRP
CLU317	Boilie Bum Bag Standard	£14.99
CLU318	Boilie Bum Bag Large	£16.99

Contents not included

FEATURES



Can be worn as a bum bag for easy 'hands-free' baiting up



CAMOLITE™ CHAIR BAG

- Unique Fox Camo pattern
- Stiffened EVA handles
- Double heavy-duty zips
- Padded removable shoulder strap
- Ideal for storing all Fox chairs
- 100%-treated 500 denier polyester

		*RRP
CLU313	Camo Chair Bag	£39.99

NEW



CAMOLITE™ AIR DRY BAGS MEDIUM & LARGE

- Supplied with free hookbait bag
- Perfect for air-drying boilies when on longer sessions
- Reinforced carry/hanging handles
- Unique Fox Camo print
- Heavy-duty zips
- 100%-treated polyester 500 denier
- Medium Dimensions: 30cm x 38cm
- Large Dimensions: 48cm x 51cm

		*RRP
CLU385	Air Dry Bag Medium	£12.99
CLU386	Air Dry Bag Large	£14.99



Contents not included

CAMOLITE™ LOW LEVEL CARRYALL

- Low profile carryall that can be stored under your bedchair
- Designed to work in conjunction with Explorer Barrow – retaining panel on rear allows carryall to be fixed to front bar of Explorer Barrow
- Two external side storage pockets – ideal for accessories such as PVA bags
- Zipped mesh storage pockets on outside side pockets
- Top pocket designed for storage of large Fox tackle box
- Main compartment perfect for storing host of tackle items including smaller Camolite Accessory Bags
- Reinforced moulded base
- Stiffened-EVA grab handles
- Padded, removable shoulder strap
- High quality heavy-duty double zips
- 100%-treated 500 denier polyester material
- Styled in unique Fox Camo pattern
- Main outer fabric: 100% Polyester
Lining: 100% Polyester
Padding/Filling: 100% Polyethylene
Base: 100% Ethylene Vinyl Acetate Copo (EVA)
- Dimensions: 54cm x 29cm x 26cm

*RRP

CLU298 Camolite Low Level Carryall £69.99



CAMOLITE™ LOW LEVEL COOLBAG

- Low profile carryall that can be stored under your bedchair
- Designed to work in conjunction with Explorer Barrow – retaining panel on rear allows carryall to be fixed to front bar of Explorer Barrow
- Main compartment is insulated with an removable/adjustable divider – perfect for storing bait and/or food and keeping it fresh
- Top pocket also insulated with a removable/adjustable divider – again perfect for food and/or bait and keeping it fresh
- Reinforced moulded base
- Stiffened-EVA grab handles
- Padded, removable shoulder strap
- High quality heavy-duty double zips
- 100%-treated 500 denier polyester material
- Styled in unique Fox Camo pattern
- Main outer fabric: 100% Polyester
Lining: 100% Polyethylene Terephthalate
Padding/Filling: 100% Polyethylene
Base: 100% Ethylene Vinyl Acetate Copo (EVA)
- Dimensions: 39cm x 29cm x 27cm

*RRP

CLU299 Camolite Low Level Coolbag £84.99



CAMOLITE™ BARROW BAG

- Perfect for use with Explorer Barrow with retaining panel on rear designed for fixing bag to Explorer Barrow
- Perfect for storing tackle, bait and clothing
- Stiffened EVA grab handles
- Removable, padded 3D shoulder strap
- External and internal mesh pockets
- Two external zipped pockets for extra storage
- Gusseted front hatch for easy access to tackle box and essentials
- Reinforced base and lid
- 10mm heavy-duty double zips
- 100%-treated 500 denier polyester material
- Styled in unique Fox Camo pattern
- Main outer fabric: 100% Polyester
Lining: 100% Polyester
Padding/Filling: 100% Polyethylene
Base: 100% Ethylene Vinyl Acetate Copo (EVA)
- Dimensions: 57cm x 31cm x 35cm

*RRP

CLU285 Camolite Barrow Bag £99.99

LOW LEVEL COOLBAG FEATURES



Insulated compartment with removable/adjustable divider



Retaining panel allows carryall to be fixed to front of Explorer Barrow



CAMOLITE™ RUCKALL

- Unique design that combines the benefits of a rucksack and carryall in one
- Padded, 3D non-slip shoulder straps and a padded back section make Ruckall very comfortable to carry
- Padded back becomes lid when Ruckall is placed on the ground
- Reinforced moulded base
- One side features a full length external storage pocket whilst the other features two smaller external storage pockets – all of which are perfect for storing a variety of accessories
- Two removable straps allow a chair and/or unhooking mat to be attached to the Ruckall for hands-free carrying
- Elasticated pocket inside lid for storage of tackle box
- Low profile allows for easy storage under your bedchair
- High quality heavy-duty double zips
- 100%-treated 500 denier polyester material
- Styled in unique Fox Camo pattern
- Main outer fabric: 100% Polyester
Lining: 100% Polyester
Base: 100% Ethylene Vinyl Acetate Copo (EVA)
- Dimensions: 50cm x 43cm x 27cm



CLU307 Camolite Ruckall *RRP
£99.99

FEATURES



Padded 3D shoulder straps



Tackle box fits inside elasticated pocket

CAMOLITE™ COOLBAG

- Features top quality thermal lining
- Available in two sizes – Standard and Large
- Ideal for storing items such as bait and food
- Designed to fit perfectly inside the central Under Barrow Bag on the Explorer barrow
- Side handles make them easy to remove from central Under Barrow Bag on Explorer barrow
- 8mm heavy-duty double zips
- 100%-treated 500 denier polyester material
- Styled in unique Fox Camo pattern
- Main outer fabric: 100% Polyester
Lining: 100% Polyethylene Terephthalate
Padding/Filling: 100% Polyethylene
- Dimensions:
Standard – L 39cm x W 18cm x H 15cm
Large – L 40cm x W 30cm x H 20cm



CLU282 Camolite Coolbag Large *RRP
£27.99
CLU283 Camolite Coolbag Standard £22.99

CAMOLITE™ STANDARD STORAGE BAG

- Ideal for storing items such as stove, gas canisters and cookware
- Designed to fit perfect inside the central Under Barrow Bag on the Explorer barrow
- Side handles make them easy to remove from central Under Barrow Bag on Explorer barrow
- 8mm heavy-duty double zips
- 100%-treated 500 denier polyester material
- Styled in unique Fox Camo pattern
- Main outer fabric: 100% Polyester
Lining: 100% Polyester
Padding/Filling: 100% Polyethylene
- Dimensions: 39cm x 15cm x 18cm



CLU284 Camolite Standard Storage Bag *RRP
£18.99

NEW



CAMOLITE™ BREW KIT BAG

- Designed using the same dimensions as Camolite Standard Storage Bag ensuring compatibility with both Explorer Barrow models
- Features stiffened Velcro internal divider
- Supplied with 2x Voyager ceramic mugs, 2x large & 2x small khaki storage screw-top pots (ideal for tea, sugar and coffee) and 1x stainless teaspoon
- Also comes supplied with a 250ml Fox-branded aluminium bottle with accompanying thermally insulated bag (ideal for storing milk in)
- Additional internal storage to fit kettle, stove and gas canister
- Side and top grab handles
- Heavy-duty double zips
- 100%-treated polyester 500 denier material featuring unique Fox Camo pattern
- Dimensions: 39cm x 15cm x 18cm

CLU323 Brew Kit Bag *RRP
£39.99



CAMOLITE™ BUZZ BAR BAG

- One side is designed to store most 3-rod buzz bars with alarms and back rests attached
- Other side houses two internal zipped pockets that are perfect for storing bite indicators, snag ears, receiver etc
- Padded central divider offers protection to buzz bars and alarms in transit
- 100%-treated 500 denier polyester material
- High quality heavy-duty double zips
- Styled in unique Fox Camo pattern
- Main outer fabric: 100% Polyester
Lining: 100% Polyester
Padding/Filling: 100% Polyethylene



*RRP

CLU300 Camo Buzz Bar Bag

£24.99



CAMOLITE™ PILLOWS

- Dual sided
- Micro-fleece on one side to keep you warm in winter
- Soft cotton on the other side to keep you cool in summer
- Removable cover can be cleaned
- Two sizes available: Standard and XL

*RRP

CLU314	Camolite Standard Pillow	£17.99
CLU315	Camolite XL Pillow	£22.99



CAMOLITE™ GLUG 6 & 8 POT CASE

- Unique Fox Camo pattern
- Double heavy-duty zips
- 8 Pot Case inc. 4 full size hookbait pots & 4 half size hookbait pots
- 6 Pot Case inc. 2 full size hookbait pots & 4 half size hookbait pots
- Padded dividers
- Tinted PVC lid for easy contents identification
- 100%-treated 500 denier polyester

*RRP

CLU310	Camolite Glug 8 Pot Case	£25.99
CLU311	Camolite Glug 6 Pot Case	£20.99



CAMOLITE™ LEAD AND BITS BAG

- Unique Fox Camo pattern
- Double heavy-duty zips
- Solid insert to prevent buckling
- Stiffened-EVA handle
- Tinted PVC lid for easy contents identification
- 100%-treated 500 denier polyester

*RRP

CLU312	Camolite Lead & Bits Bag	£25.99
--------	--------------------------	--------



CAMOLITE™ HOT WATER BOTTLE

- Fleece and cotton combo
- Unique Fox Camo pattern
- Neoprene-lined to retain heat for longer
- Water bottle supplied

*RRP

CLU316	Camolite Hot Water Bottle	£14.99
--------	---------------------------	--------



CAMOLITE™ ACCESSORY BAG LARGE

- Perfect for storing accessories such as PVA, Edges end tackle, Zig and floater fishing items etc
- Clear lid allows for easy identification of contents
- Low profile grab handle
- High quality Heavy-duty double zips
- 100%-treated 500 denier polyester material
- Styled in unique Fox Camo pattern
- Main outer fabric: 70% Polyester, 30% PVC. Lining: 100% Polyester
- Dimensions: 16cm x 9.5cm x 27cm



*RRP

CLU303 Camolite Accessory Bag Large £14.99

CAMOLITE™ ACCESSORY BAG SLIM

- Perfect for storing accessories such as Zig floats, Impact Spods and Edges end tackle
- Clear lid allows for easy identification of contents
- Low profile grab handle
- High quality heavy-duty double zips
- 100%-treated 500 denier polyester material
- Styled in unique Fox Camo pattern
- Main outer fabric: 70% Polyester, 30% PVC. Lining: 100% Polyester
- Dimensions: 9.5cm x 9.5cm x 27cm



*RRP

CLU304 Camolite Accessory Bag Slim £14.99

CAMOLITE™ ACCESSORY BAG MEDIUM

- Perfect for storing accessories such as line, Edges end tackle, tools etc
- Clear lid allows for easy identification of contents
- Low profile grab handle
- High quality heavy-duty double zips
- 100%-treated 500 denier polyester material
- Styled in unique Fox Camo pattern
- Main outer fabric: 70% Polyester, 30% PVC. Lining: 100% Polyester
- Dimensions: 13cm x 9.5cm x 16.5cm



*RRP

CLU302 Camolite Accessory Bag Medium £12.99

CAMOLITE™ ACCESSORY BAG SMALL

- Perfect for storing accessories such as rig tools, Edges end tackle and leads
- Clear lid allows for easy identification of contents
- Low profile grab handle
- High quality heavy-duty double zips
- 100%-treated 500 denier polyester material
- Styled in unique Fox Camo pattern
- Main outer fabric: 70% Polyester, 30% PVC. Lining: 100% Polyester
- Dimensions: 8.5cm x 9.5cm x 13cm



*RRP

CLU301 Camolite Accessory Bag Small £8.99

FEATURES



Large perfect for items like PVA and Impact Spods

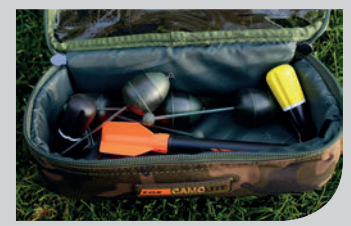

Slim ideal for items like Zig and Marker Floats



Medium suited to a variety of products

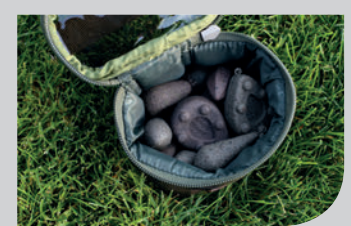

Small ideal for storing your chosen leads

NEW



CAMOLITE™ ACCESSORY BAG MINI

- Unique Fox Camo pattern
- Double heavy-duty zips
- 2 adjustable internal dividers
- Tinted PVC lid with storage wallet
- Ideal as a baiting-up pouch holding all required preventing the need to take out your tackle box
- 100%-treated 500 denier polyester
- Dimensions: 8cm x 7.5cm x 13cm

*RRP

CLU319 Camolite Accessory Bag Mini £8.49



VOYAGER® 3+3 ROD CASE 12FT

- Unique design to maximise rod and reel storage space
- Designed to accommodate up to six made-up rods with reels
- Will comfortably fit 50mm K-Series guides and large, big pit reels such as FX13
- Sculpted fit to reduce bulk
- Reinforced PU board in all key areas including reel and guide sections
- Rods fit into the case with the reel and guides facing downwards
- Rod butt end slots into the padded hoods at each end whilst the tip end is secured in place by Velcro strap
- Three internal padded dividers – two rods fit into each section with (one rod pointing up and one rod pointing down)
- Three external storage pockets for holding items such as spods, marker floats, leads and essential rig bits
- Large external pocket with full-length zip for storing landing net, banksticks and marker sticks
- Stiffened-EVA grab handles
- 10mm heavy-duty double zips
- Hydratec water-resistant fabric (100%-treated 1050 denier polyester)
- Dimensions: H 197cm x W 37cm x D 21cm

*RRP

CLU329 Voyager 12ft 3+3 Rod Case £149.99



VOYAGER® 3+3 ROD CASE 13FT

- Unique design to maximise rod and reel storage space
- Designed to accommodate up to six made-up rods with reels
- Will comfortably fit 50mm K-Series guides and large, big pit reels such as FX13
- Sculpted fit to reduce bulk
- Reinforced PU board in all key areas including reel and guide sections
- Rods fit into the case with the reel and guides facing downwards
- Rod butt end slots into the padded hoods at each end whilst the tip end is secured in place by Velcro strap
- Three internal padded dividers – two rods fit into each section with (one rod pointing up and one rod pointing down)
- Three external storage pockets for holding items such as spods, marker floats, leads and essential rig bits
- Large external pocket with full-length zip for storing landing net, banksticks and marker sticks
- Stiffened-EVA grab handles
- 10mm heavy-duty double zips
- Hydratec water-resistant fabric (100%-treated 1050 denier polyester)
- Dimensions: H 214cm x W 37cm x D 21cm

*RRP

CLU330 Voyager 13ft 3+3 Rod Case £159.99

FEATURES



Hydratec fabric



Handy storage pockets on all 12ft and 13ft Rod Cases



Padded protection at both ends of rod



Heavy-duty 10mm zips



Reversible shoulder straps



VOYAGER® 2+2 ROD CASE 10FT

- Unique design to maximise rod and reel storage space
- Designed to accommodate up to four made-up 10ft rods with reels
- Will comfortably fit 50mm K-Series guides and large, big pit reels such as FX13
- Sculpted fit to reduce bulk
- Reinforced PU board in all key areas including reel and guide sections
- Rods fit into the case with the reel and guides facing downwards
- Rod butt end slots into the padded hoods at each end whilst the tip end is secured in place by Velcro strap and then protected by a Velcro-secured flap
- Two internal padded dividers – two rods fit into each section with (one rod pointing up and one rod pointing down)
- Large external pocket with full-length zip for storing landing net, banksticks and marker sticks
- Stiffened-EVA grab handles
- 10mm heavy-duty double zips
- Hydratec water-resistant fabric (100%-treated 1050 denier polyester)
- Dimensions: H 166cm x W 25cm x D 21cm

*RRP

CLU331 Voyager 10ft 2+2 Rod Case £89.99



VOYAGER® 2+2 ROD CASE 12FT, 13FT

- Unique design to maximise rod and reel storage space
- Designed to accommodate up to four made-up rods with reels
- Will comfortably fit 50mm K-Series guides and large, big pit reels such as FX13
- Sculpted fit to reduce bulk
- Reinforced PU board in all key areas including reel and guide sections
- Rods fit into the case with the reel and guides facing downwards
- Rod butt end slots into the padded hoods at each end whilst the tip end is secured in place by Velcro strap
- Two internal padded dividers – two rods fit into each section with (one rod pointing up and one rod pointing down)
- Three external storage pockets for holding items such as spods, marker floats, leads and essential rig bits
- Large external pocket with full-length zip for storing landing net, banksticks and marker sticks
- Stiffened-EVA grab handles
- 10mm heavy-duty double zips
- Hydratec water-resistant fabric (100%-treated 1050 denier polyester)
- 12ft Dimensions: H 197cm x W 25cm x D 21cm
- 13ft Dimensions: H 214cm x W 25cm x D 21cm

*RRP

CLU327 Voyager 12ft 2+2 Rod Case £129.99

CLU328 Voyager 13ft 2+2 Rod Case £139.99



VOYAGER® TRI SLEEVE 12FT

- Designed to store three made-up rods
- Sculpted to accommodate big pit reels, 50mm butt rings and K-Series guides
- Padded internal dividers
- Reinforced base
- External storage pockets for leads and rig bits
- 10mm heavy-duty double zips
- Stiffened-EVA grab handles
- Reversible, padded shoulder strap
- New Hydratec water-resistant fabric (100%-treated 1050 denier polyester)
- Dimensions: H 192cm x W 38cm

*RRP

CLU332 Voyager Tri Sleeve 12ft £99.99



VOYAGER® ROD SLEEVE 10FT, 12FT, 13FT

- Available in 10ft, 12ft and 13ft
- Designed to store one made-up rod
- Sculpted to accommodate big pit reels, 50mm butt rings and K-Series guides
- 10mm heavy-duty double zips
- Stiffened-EVA grab handles
- New Hydratec water-resistant fabric (100%-treated 1050 denier polyester)
- Dimensions:
10ft: H 168cm x W 24cm
12ft: H 198cm x W 24cm
13ft: H 210cm x W 24cm

		*RRP
CLU333	Voyager Rod Sleeve 10ft	£31.99
CLU334	Voyager Rod Sleeve 12ft	£34.99
CLU335	Voyager Rod Sleeve 13ft	£36.99



VOYAGER® BROLLY CARRYALL

- Ideal for use with Royale and Ultra Brolly ranges
- Voyager Tri Sleeve and Single Jackets can fit in outside pocket and strap to outside of carryall
- Moulded base and top
- 10mm heavy-duty double zips
- Stiffened-EVA grab handles
- Reversible, padded shoulder strap
- New Hydratec water-resistant fabric (100%-treated 1050 denier polyester)
- Dimensions: H 197cm x W 20cm

		*RRP
CLU336	Voyager Brolly Carryall	£44.99



VOYAGER® ACCESSORY BAG SMALL

- Ideal for storing essential items such as rig bits, leads, lighters and head torch
- Tinted clear lid
- Polyester webbing grab handle
- 10mm heavy-duty zip
- New Hydratec water-resistant fabric (100%-treated 1050 denier polyester)
- Dimensions: H 9cm x W 13cm x D 8cm

CLU346 Voyager Accessory Bag S

*RRP

£8.99



VOYAGER® ACCESSORY BAG MEDIUM

- Ideal for storing essential items such as rig bits, leads, scissors, PVA bags, lighters and head torch
- Tinted clear lid
- Polyester webbing grab handle
- 10mm heavy-duty zip
- New Hydratec water-resistant fabric (100%-treated 1050 denier polyester)
- Dimensions: H 9cm x W 16cm x D 13cm

CLU347 Voyager Accessory Bag M

*RRP

£11.99



VOYAGER® ACCESSORY BAG LARGE

- Ideal for storing essential items such as PVA dispensers, Impact Spods, rig bits, leads, Zig Floats, lighters and head torch
- Tinted clear lid
- Polyester webbing grab handle
- 10mm heavy-duty double zips
- New Hydratec water-resistant fabric (100%-treated 1050 denier polyester)
- Dimensions: H 10cm x W 27cm x D 17cm

CLU348 Voyager Accessory Bag L

*RRP

£13.99



VOYAGER® COMPACT BARROW BAG

- Perfect for storing tackle, bait and clothing
- Adjustable internal divider for keeping tackle box separate to main compartment but maintaining quick access via gusseted front hatch
- Perfect for use with Explorer and Explorer Deluxe barrows
- Adjustable retaining panel on rear with Velcro fastening to make attaching to front bar of both Explorer barrow models very easy
- Stiffened-EVA grab handles
- Removable, padded 3D shoulder strap
- External and internal mesh pockets
- Two external zipped pockets for extra storage
- Reinforced base and lid
- 10mm heavy-duty double zips
- New Hydratec water-resistant fabric (100%-treated 1050 denier polyester)
- Dimensions: H 35cm x W 57cm x D 31cm



VOYAGER® BARROW BAG

- Designed to fit most barrows on the market maximising storage space both in your swim and in transit
- Massive main compartment capacity
- Four exterior pockets: 2 x front pockets (biggest one holds large double F Box, smaller one ideal for accessory bags), 2 x side pockets ideal for tackle essentials
- Side pockets each have external Velcro-fastened meshed pouches
- Moulded base and lid
- PU boards inside give a totally rigid body
- EVA grab handles on both sides for easy lifting and loading
- Removable, padded 3D shoulder strap
- Three zipped mesh pockets inside lid provide extra storage room
- 10mm heavy-duty double zips
- New Hydratec water-resistant fabric (100%-treated 1050 denier polyester)
- Dimensions: H 39cm x W 79cm x D 49cm

CLU340 Voyager Compact Barrow Bag ***RRP**
£84.99

CLU338 Voyager Barrow Bag ***RRP**
£129.99

VOYAGER® RUCKALL

- Unique design that combines the benefits of a rucksack and carryall in one
- Padded, 3D non-slip shoulder straps and a padded back section make Ruckall very comfortable to carry
- Padded back becomes lid when Ruckall is placed on the ground
- Reinforced moulded base
- One side features a full-length external storage pocket whilst the other features two smaller external storage pockets – all of which are perfect for storing a variety of accessories
- Two removable straps allow a chair and/or unhooking mat to be attached to the Ruckall for hands-free carrying
- Elasticated pocket inside lid for storage of tackle box
- Low profile allows for easy storage under your bedchair
- High-quality heavy-duty double zips

- New Hydratec water-resistant fabric (100%-treated 1050 denier polyester)
- Dimensions: H 35cm x W 57cm x D 31cm



CLU343 Voyager Ruckall ***RRP**
£84.99

Contents not included

FEATURES



Many items feature moulded bases



Heavy-duty buckles and clips



Compact Barrow Bag works with Explorer Barrow



VOYAGER® LARGE CARRYALL

- Designed to house all of your essential tackle items such as tackle box, weighing scales, head torch, PVA, hookbaits, spare clothes, baiting tools etc
- Moulded base
- Four external pockets: 2 x side pockets, pocket on lid plus front pocket (will hold large double F Box)
- Side pockets each have external Velcro-fastened meshed pouches
- 10mm heavy-duty double zips
- Stiffened-EVA grab handles
- Removable, padded 3D shoulder strap
- New Hydratec water-resistant fabric (100%-treated 1050 denier polyester)
- Dimensions: H 43.5cm x W 64cm x D 40cm

CLU337 Voyager Large Carryall ***RRP**
£79.99



VOYAGER® LOW LEVEL CARRYALL

- Low profile carryall that can be stored under your bedchair
- Designed to work in conjunction with Explorer and Deluxe Explorer barrows
- Adjustable retaining panel on rear with Velcro fastening to make attaching to front bar of both Explorer barrow models very easy
- Two external side storage pockets - ideal for accessories such as PVA etc
- Zipped mesh storage pockets on outside side pockets
- Top pocket designed for storage of large Fox tackle box
- Main compartment perfect for storing host of tackle items including smaller accessory bags

- Reinforced moulded base
- EVA grab handles
- Removable, padded 3D shoulder strap
- 10mm heavy-duty double zips
- New Hydratec water-resistant fabric (100%-treated 1050 denier polyester)
- Dimensions: H 26cm x W 54cm x D 29cm

*RRP

CLU341 Voyager Low Level Carryall £64.99

VOYAGER® LOW LEVEL COOLER

- Low profile insulated carryall that can be stored under your bedchair
- Designed to work in conjunction with Explorer and Deluxe Explorer barrows
- Adjustable retaining panel on rear with Velcro fastening to make attaching to front bar of both Explorer barrow models very easy
- Will also fit perfectly inside the central Under Barrow Bag on the Explorer and Explorer Deluxe barrows
- Insulated with 2 x removable/adjustable dividers – perfect for storing bait and/or food and keeping it fresh
- Front and side handles makes it easy to remove from central Under Barrow Bag on Explorer barrows and from underneath your bedchair
- Reinforced moulded base
- EVA grab handles
- Removable, padded 3D shoulder strap
- 10mm heavy-duty double zips
- New Hydratec water-resistant fabric (100%-treated 1050 denier polyester)
- Dimensions: H 15cm x W 54cm x D 29cm



*RRP

CLU342 Voyager Low Level Cooler £74.99

VOYAGER® LARGE COOLER

- Features top quality thermal lining
- Ideal for storing items such as bait and food that need to be kept fresh
- Removable internal divider
- Internal mesh storage pocket
- Designed to fit perfectly inside the central Under Barrow Bag on the Explorer Barrow and Explorer Deluxe barrow (with shelf removed)
- Side handle makes it easy to remove from central Under Barrow Bag on Explorer barrows and from underneath your bedchair
- 10mm heavy-duty double zips
- New Hydratec water-resistant fabric (100%-treated 1050 denier polyester)
- Dimensions: H 30cm x W 40cm x D 20cm



*RRP

CLU326 Voyager Large Cooler £34.99

FEATURES



Water-resistant Hydratec fabric



Low Level bags fit under bedchair



Large Cooler is insulated and features divider



Contents not included

VOYAGER® GADGETS SAFE

- Unique design for storing 'gadget' items such as small power packs, iPad, chargers, head torch etc
- Access port on side for easy access to power pack for charging phones, head torch etc
- Mesh side pocket on top for holding phone when being charged
- High-quality heavy-duty double zips
- EVA grab handle
- New Hydratec water-resistant fabric (100%-treated 1050 denier polyester)
- Dimensions: H 9cm x W 30cm x D 23cm

*RRP

CLU344 Voyager Gadgets Safe £24.99



VOYAGER® 2 MAN COOLER

- Perfect for storing food and helping to keep it fresh
- Supplied with 2 x square plates, 2 x ceramic mugs, 2 x knives, 2 x forks, 2 x tablespoons, 1 x teaspoon, 1 x corkscrew/bottle opener, 1 x chopping board, 4 x storage pots (2 x large and 2 x small) all of which are stored in the lid section
- Thermally-lined, wipe-clean main compartment with a thermal zip baffle to prevent heat loss
- Two thermally-lined side pockets with thermal zip baffles
- Moulded base and lid
- EVA grab handles
- Removable, padded 3D shoulder strap
- 10mm heavy-duty double zips
- New Hydratec water-resistant fabric (100%-treated 1050 denier polyester)
- Dimensions: H 46cm x W 55cm x D 32cm

CLU339 Voyager 2 Man Cooler *RRP
£129.99



Contents not included

VOYAGER® BED BAG

- Designed to fit all sizes of Fox bedchair and most others on the market
- Roll down top with fastening buckles allows bag to fit various sizes of bedchair
- ¾ length zips make it easy to insert and take out bedchairs
- EVA grab handles
- Removable, padded 3D shoulder strap
- 10mm heavy-duty double zips
- New Hydratec water-resistant fabric (100%-treated 1050 denier polyester)

CLU345 Voyager Bed Bag *RRP
£59.99



VOYAGER® COOLER BAG

- Features top-quality thermal lining
- Ideal for storing items such as bait and food that need to be kept fresh
- Designed to fit perfectly inside the central Under Barrow Bag on the Explorer and Explorer Deluxe barrows
- Side handle makes it easy to remove from central Under Barrow Bag on Explorer barrows and from underneath your bedchair
- 10mm heavy-duty double zips
- New Hydratec water-resistant fabric (100%-treated 1050 denier polyester)
- Dimensions: H 15cm x W 39cm x D 18cm

CLU325 Voyager Cooler Bag *RRP
£24.99



Contents not included

VOYAGER® STORAGE BAG

- Ideal for storing items such as stove, gas canisters and cookware
- Designed to fit perfectly inside the central Under Barrow Bag on the Explorer and Explorer Deluxe barrows
- Side handle makes it easy to remove from central Under Barrow Bag on Explorer barrows and from underneath your bedchair
- 10mm heavy-duty double zips
- New Hydratec water-resistant fabric (100%-treated 1050 denier polyester)
- Dimensions: H 15cm x W 39cm x D 18cm

CLU324 Voyager Storage Bag *RRP
£19.99



AQUOS® EVA BAGS

- Waterproof EVA construction with welded seams to prevent water ingress
- Oversized lid
- Heavy-duty double zips
- Polyester webbing handles with EVA comfort grip
- Scuff pads on base
- Ideal for boat users who want to keep tackle items dry
- Can also be used for holding bait/spod mixes or wet items such as sacks, clothes, waders (30L only) etc

- Dimensions:
20L - 37cm x 26cm x 27cm
30L - 40cm x 26cm x 30cm

		*RRP
CLU321	Aquos EVA Bag 20L	£20.99
CLU322	Aquos EVA Bag 30L	£24.99

FEATURES



Waterproof EVA construction with welded seams to prevent water ingress



Polyester webbing handles with EVA comfort grip



Scuff pads on base



TIP & BUTT PROTECTORS

- Neoprene protectors that tip and butt sections slot into for secure transportation
- Wider protector for butt grip, whilst narrower one goes at tip end
- Velcro fastening to secure protectors in place



ROD & LEAD BANDS

- Handy bands for securing two halves of rod together
- Bands simply wrap around rods and Velcro in place
- Also enables you to secure the lead in place when packing rods away with lead still attached, so it doesn't swing around and damage rod blank

		*RRP
CAC553	Tip & Butt Protectors	£8.99

		*RRP
CAC552	Rod & Lead Bands	£6.99

NEW

FOX CAMO NEOPRENE



CAMO REEL CASE

- Neoprene case for protecting reel in transit that features unique Fox Camo print
- Velcro fastening to secure case around rod and reel
- Featuring a single-zipped lead pocket

		*RRP
CLU393	Camo Neoprene Reel Pouch	£15.99



CAMO TIP AND BUTT PROTECTORS

- Unique Fox Camo print Neoprene protectors that tip and butt sections slot into for secure transportation
- Wider protector for the butt grip, whilst narrower ones goes at tip end
- Velcro fastening to secure protectors in place

		*RRP
CLU389	Camo Neoprene Tipp & Butt Protectors	£9.99



Contents not included

CAMO GAS CANISTER CASE

- Unique Camo Neoprene main body
- Hard-wearing Zipped base for easy insertion of gas canister
- Two elasticated retaining loops, one for lighter and one for spoon
- Will fit most 500g canisters

		*RRP
CLU391	Camo Neoprene Gas Cannister Cover	£10.99



Contents not included

CAMO COOKSET BAG

- Neoprene case for storing Fox Cooksets that features unique Fox Camo print
- Designed to accommodate standard 3-piece or larger 4-piece Fox Cooksets
- 8mm heavy-duty double zip
- Stiffened-EVA grab handle

		*RRP
CLU392	Camo Neoprene Cookset Bag	£13.99



STAINLESS STEEL MUG

- Features our catchy slogan: Find 'em, Feed 'em, Fox 'em
- Designed to keep your hot drinks warmer for longer
- Easy to clean

		*RRP
CLU254	Stainless Black XL 400ml Mug	£10.99



ROYALE® MUG

- Carpy green plastic mugs that are perfect for hot drinks
- Features gold Fox head

		*RRP
CLU252	Royale Mug	£3.25



CERAMIC SCENIC MUG

- Ceramic mug for hot drinks
- Features unique 'carpy' scenic print

		*RRP
CLU394	Ceramic Scenic Mug	£4.99

BARROWS



EXPLORER® BARROW DELUXE

- Based on same unique design as original Explorer barrow but with some added extras!
- Designed to allow anglers to fish 'off of the barrow' making it ideal for short-session anglers that like to keep mobile, but also equally as good for anglers that need to carry those essential extras
- Main differences to standard Explorer: longer ergonomically-shaped, removable handles, wider compartments and mesh pockets either side of wheel for storing essentials such as water bottle, adjustable height on front barrow rack allowing 2 x Low Level bags or 1 x Low Level and 1 x Compact Barrow Bag to be attached and supplied with a Voyager Under Barrow Bag
- Voyager Under Barrow Bag features hard base to prevent sagging, a removable shelf to allow Storage Bags to be separated and side access zips to allow the contents of the bag to be accessed without unloading the barrow
- Another feature of the Voyager Under Barrow Bag is a zipped external pocket that houses a waterproof rain cover, which is styled in the Fox Camo pattern
- Features extendable front barrow bag rack – this allows the Voyager or Camolite Compact Barrow Bags or Low Level Bags (all available separately) to sit right at the front of the barrow when using the barrow in 'session mode' and carrying a bedchair. However, when fishing day sessions without a bed, simply retract the front rack and turn the Barrow/Low Level Bags around so they face you. The design ensure the barrow remains balanced whether in short or long session mode
- Further features include robust, hi-tensile steel frame, quick-release wheel system with pneumatic tyre and swivelling mud feet with spiked bases
- Compact design and packs down very small for fitting in smallest of car boots
- Supplied with two Universal Barrow Straps that fit to barrow via looped attachments on frame
- Compatible with both the Voyager and Camolite luggage ranges

*RRP

CTR013 Explorer Deluxe Barrow £199.99



EXPLORER® BARROW

- Unique design makes it one of the most versatile carp barrows ever released
- Designed to allow anglers to fish 'off of the barrow' making it ideal for short-session anglers that like to move swims a lot
- Extendable front barrow bag rack – this allows the Camolite Barrow Bag (available separately) to sit right at the front of the barrow when using the barrow in 'session mode' and carrying a bedchair. When fishing days without a bed, simply retract the front rack and turn the Barrow Bag round so it faces you. The design ensure the barrow remains balanced whether in short or long session mode
- Ergonomically-shaped removable handles
- Robust, hi-tensile steel frame that is built to last
- Quick-release wheel system with pneumatic tyre
- Swivelling mud feet with spiked bases
- Compact design and packs down very small for fitting in smallest of car boots
- Supplied with two FX Universal Barrow Straps that fit to barrow via looped attachments on frame
- Supplied with camo storage bag that simply drops in to the centre of the frame, which can then be loaded with tackle items including Camolite Storage Bags that are available separately
- Camo storage bag has side access points so contents can be taken out without unloading barrow
- Supplied with two mesh storage pockets (with side access) that sit either side of wheel for storing water bottle etc
- Compatible with our Camolite luggage range

*RRP

CTR012 Explorer Barrow £189.99

FEATURES



Mesh pockets feature side access and are ideal for water bottles



Deluxe Under Barrow Bag features shelf



Extending front bar allows two bags to be attached

NEW



Barrow not included

CAMO BARROW COVER

- Designed specifically for use with Fox Explorer Barrows, however, will fit most barrows on the market
- Unique Fox camo pattern
- 5000mm Hydrostatic Head
- Fully-taped seams
- Elasticated hem

*RRP

CTR014 Camo Barrow Cover £24.99





ROYALE® CARP BARROW

- Packed with features that make it offer incredible value for money
- Extra wide design to fit all of your kit
- Quick and simple load length adjustment
- Quick release wheel system
- Compression strap attachment points on frame for use with FX Universal Barrow Straps
- Ergonomically-shaped handles
- Low profile
- Swivelling mud feet with spiked bases for extra stability
- Pneumatic tyre and wheel bearings
- Supplied with free under barrow bag

*RRP

CTR009 **Royale Carp Barrow with Bag** **£119.99**

FEATURES



Compact when packed away



Supplied with pneumatic tyre



Welded loops for attaching FX Universal Barrow Straps



Ergonomically designed handles



ROYALE® XT CARP BARROW

- Based on same design as standard Royale, but with addition of extending sides
- Extra-wide design to fit all of your kit
- Quick and simple load length adjustment
- Adjustable side support
- Quick release wheel system
- Compression strap attachment points on frame for use with FX Universal Barrow Straps
- Ergonomically-shaped handles
- Low profile
- Swivelling mud feet with spiked bases for extra stability
- Pneumatic tyre and wheel bearings
- Supplied with free under barrow bag

*RRP

CTR010 **Royale Carp Barrow XT with Bag** **£139.99**



BOATS & ENGINES

Four years ago our product design team sat down with some of our European consultants to work on our first-ever inflatable boat. It's fair to say that since then, the popularity of Fox inflatable boats has grown year on year, and so has the variety of the range. We now offer five different sizes of FX models, from the two-metre FX200, up to the new FX420 Boat Bivvy. All bases are now covered, from baiting up and placing rigs, to landing fish and even fishing overnight.

The FX420 Boat Bivvy is new for 2019 and is a product we're extremely proud of. We worked very closely with some of the best European boat anglers to ensure the design will meet the needs of this rather specialist angling technique.

In addition to the range of inflatable boats, we also produce electric outboards to power them. New for 2019 are two larger models ideal for powering bigger boats like our FX420. There's the new FX Pro in 65lb - the fourth model in our Pro range. Then there's a real beast: our first-ever brushless engine of 80lb... a highly-impressive piece of equipment!



FX PRO ELECTRIC OUTBOARD MOTORS

- Four sizes available – 35lb, 45lb, 55lb and 65lb
- 65lb model features adjustable controller head
- Aluminium shaft (black on 65lb)
- Quick-release shaft with multiple angle fixings
- Battery drain on top
- All models are 12v
- Nylon reinforced brackets
- Polycarbonate propeller
- Aluminium motor housing
- 35lb model features two blade propeller
- 45lb, 55lb and 65lb models feature three blade propeller

		*RRP
CEN006	FX Pro 35lbs 2 Blade	£209.99
CEN007	FX Pro 45lbs 3 Blade	£229.99
CEN008	FX Pro 55lbs 3 Blade	£249.99
CEN009	FX Pro 65lbs 3 Blade	NEW £269.99

FEATURES



Polycarbonate propellers



LED 'easy-to-see' speed settings and battery life



Easy-fit bracket

NEW

FOX 80LB 12V BL ENGINE

- 80lb brushless thrust for use with large boats in strong winds
- Features latest in brushless 12Volt long-term technology
- High efficiency technology with NdFeb Magnet
- 65% more efficient than standard electric motor
- 17% more efficient than known brushless technology
- Volt LED indicator
- Water-cooled
- Low battery protection
- Overheating protection
- Low current starting
- Rotation protection
- Infinitely variable gears/gearless
- Quick 'one-touch' release shaft with multiple angle fixings
- Extendable aluminium transom mount
- Stainless steel long-life fittings
- Black strong glass fibre shaft
- Total length: 115cm
- Polycarbonate 3-blade prop
- Aluminium motor housing

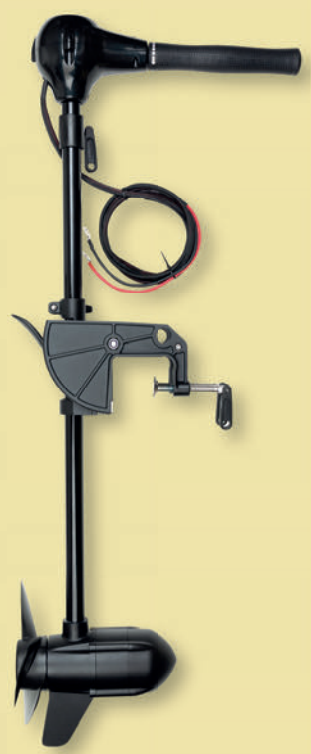

		*RRP
CEN010	80lbs 12v BL Engine	£699.99



RECHARGEABLE AIR PUMP/DEFLATOR

- Battery-powered pump for inflating and deflating of boats
- 12v/240v
- Only supplied with European two-prong plug socket

		*RRP
CIB003	Rechargeable Air Pump / Deflator	£39.99

NEW



FX 420 CAMO BOAT BIVVY

Following the huge success of our FX range of inflatable boats, we have been inundated with requests from anglers across Europe, to produce a boat bivvy capable of meeting the demands of the modern carp angler. The result is the FX420 Boat Bivvy...

BOAT

- Designed specifically to feature our bivvy concept and offer a complete boat bivvy package
- Integrated Stainless D-Ring bivvy securing points
- 0.9mm heavy-duty fabric featuring unique Fox Camo pattern
- 4.2m long with increased internal dimensions for maximum use of space
- Independent inflatable keel for stability
- Full black aluminium floor
- Reinforced side and under-rails for maximum protection
- Additional grab handles
- Fully-adjustable rail seat
- Black oars supplied with square paddles and for maximum performance
- Stainless front towing/anchor point
- Double-sealed hard transom with reinforced mounting points for engine and echo sounder
- Packed size of boat: 155cm x 70cm x 45cm
- Packed size of floor: 127cm x 70cm x 15cm
- Total weight: 108kg (boat 70kg, floor 38kg)
- Max load: 1063kg
- Max power: 30HP

BIVVY

- Designed to fit to supplied FX420 Camo Boat
- Features rigid aluminium frame and support poles
- Constructed from Fox Camo Ventec Rip Stop fabric (20,000mm hydrostatic head)
- Internal mesh pockets for 'off the floor' storage
- Front mesh vent for increased airflow
- Rear entrance features a full-length zip that allows user to choose between solid camo panel or the camo mozzie mesh panel
- Designed to accommodate compact, standard and XL bedchairs lengthways or a compact bedchair (such as Flatlitr Compact) width ways
- Total weight: 9.7kg
- Bivvy height: 1.54m

*RRP

CIB017 FX 420 Inflatable Boat Bivvy £1,999.99

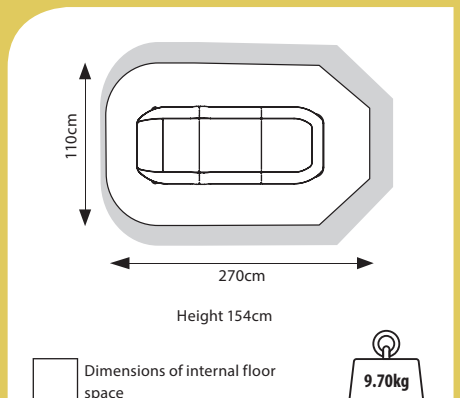
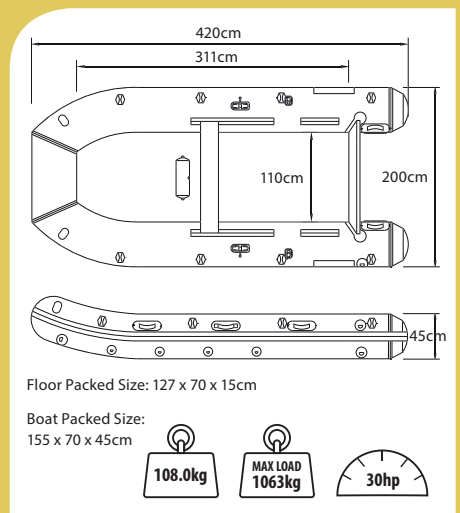



FEATURES



Rear bivy door open



Rear bivy door with clear PVC



Rear bivy door with mesh



Front window with clear PVC



Front window open



Front window with mesh

FX320 FOX



Includes footpump

FEATURES



Reinforced mounting points for engines etc.

FX 320

- The second largest boat of our FX range measuring 3.2 metres
- Perfect for long sessions and anglers that like to fish from the boat
- Designed to be highly stable when on water even in trying conditions
- Heavy-duty 0.9mm olive fabric
- Additional grab handles
- Fully-adjustable rail seat
- Reinforced side and under-rails for maximum protection
- Black oars supplied
- Square paddles for better performance
- Stainless front towing/anchor point
- Supplied with hard back for use with reinforced mounting points for engine and echo sounder
- Independent inflatable keel for stability
- Supplied with foot pump
- Independent hard back marine plywood floor with aluminium slats
- Fox Camo version now also available

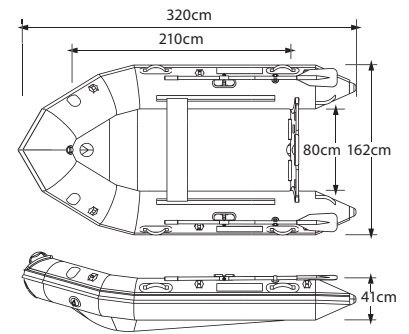

Packed Size:
112 x 58 x 32cm

64.0kg MAX LOAD 560kg 15hp

		*RRP
CIB006	FX320 Inflatable Boat	£1,049.99
CIB016	FX320 Camo Inflatable Boat	£1,199.99

FX290 FOX



Includes footpump



Stainless steel towing or anchor loop

FX 290

- Highly-versatile model that is perfect for a host of tasks such as rig placement, baiting up, landing fish and even fishing directly from
- Designed to be highly stable when on water even in trying conditions
- Heavy-duty 0.9mm olive fabric
- Supplied with 2.9m green air mattress floor
- Additional grab handles
- Fully-adjustable rail seat
- Reinforced side and under-rails for maximum protection
- Black oars supplied
- Square paddles for better performance
- Stainless front towing/anchor point
- Supplied with hard back for with reinforced mounting points for engine and echo sounder
- Independent inflatable keel for stability
- Independent heavy-duty fibrous air mattress with easy access keel hole
- Supplied with foot pump
- Fox Camo version also available and supplied with a marine ply floor

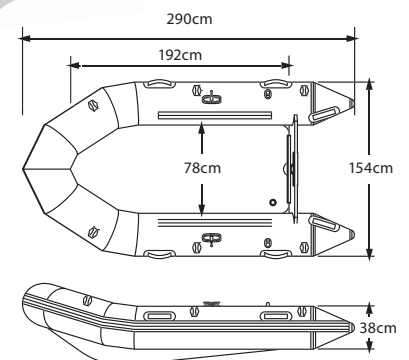

Packed Size:
110 x 58 x 35cm

40.0kg MAX LOAD 510kg 10hp

		*RRP
CIB002	FX290 Inflatable Boat	£839.99
CIB015	FX290 Camo Inflatable Boat	£974.99

FX240 FOX

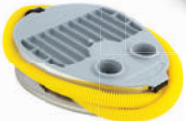

Includes footpump

FX 240

- A great all-rounder that is ideal for a host of jobs such as baiting up, rig placement, moving swims and landing fish
- Measure 2.4m long
- Heavy-duty 0.9mm olive fabric
- Additional grab handles
- Fully-adjustable rail; seat for maximum adjustability
- Reinforced side and under-rails for maximum protection
- Black oars
- Square paddles for better performance
- Stainless front towing/anchor point
- Supplied with hard back for with reinforced mounting points for engine and echo sounder
- Marine ply floor (can be packed away assembled)
- Supplied with foot pump
- Fox Camo version also available

		*RRP
CIB004	FX240 Inflatable Boat	£599.99
CIB014	FX240 Camo Inflatable Boat	£629.99

FEATURES



Top quality rowlock

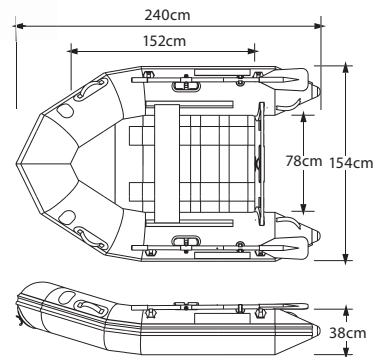

Packed Size:
105 x 58 x 32cm

32.0kg MAX LOAD 240kg 5hp

FX200 FOX



Includes footpump

FX 200

- Smallest of our FX range at 2m long
- Supplied with hard back for with reinforced mounting points for engine and echo sounder
- 0.7mm Fox Camo fabric
- Additional grab handles
- Fully-adjustable rail seat
- Reinforced side and under-rails for maximum protection
- Supplied with 2 x two piece black oars
- Stainless front towing/anchor point
- Marine ply floor (can be packed away with floor assembled)
- Supplied with foot pump

		*RRP
CIB013	FX 200 Camo Inflatable Boat	£574.99



Reinforced rails for protection

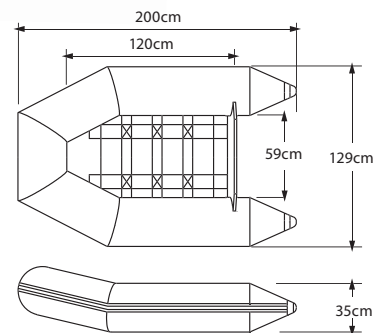

Packed Size:
110 x 58 x 35cm

22.0kg MAX LOAD 200kg 2.2hp



ROD SUPPORT

Here at Fox, we don't make tackle for just one particular type of carp angler. We are a brand that tries our best to make products that appeal to anglers of all orientations. Whether you fish long sessions or short, lakes or rivers, small venues or large, target the biggest of carp or simply enjoy getting bites, our vast array of products will cover your needs. One area where this philosophy shines through is our rod support portfolio. The range covers a wide variety of angling situations, ensuring that whatever your preferred approach, you're sure to find the perfect product.

In the coming pages you'll not only find a variety of rod pod designs that cover small venues right up to the largest, most extreme waters, but also banksticks and buzz bars. In addition, we also offer accessories such as back rests, snag ears and stabilisers to ensure the complete package is available.

SKY POD



Includes carry case

SKY POD® - 3 ROD

- Purposely engineered to give incredible stability when fishing on large continental lakes and big powerful rivers
- Body length adjustable to suit all standard rod lengths
- Adjustable leg splay
- Rods may be positioned anywhere from below the horizontal to almost the vertical plane
- Rear buzz bar can be positioned along the length of the body
- Profiled aluminium body and buzz bars guarantee a wobble-free set up
- Complete with FREE carry case

*RRP

RP3573	Sky Pod 3-Rod and Carry Bag	£349.99
--------	-----------------------------	---------

FEATURES



The uniquely-shaped body of the Sky Pod guarantees a solid set up with cam locks giving secure adjustment



Ergonomically-designed thumbscrews allow precise pitch adjustment of the buzz bars



Brass threads for secure fix of alarms and back rests



SKY POD® BUTT CAP

*RRP

RP3576	Sky Pod Butt Caps	£7.99
--------	-------------------	-------

Length Dimensions:
from 105cm to 205cm

Height Dimensions:
from 16.5cm to 94cm (short legs)
from 114cm to 192cm (long legs)

Width Dimensions:
76cm to 140cm (between long legs)

RANGER MKII

Includes carry case



RANGER® MK2 POD 3 ROD & 4 ROD

- One of the most versatile rod pods ever made!
- Unique leg locking mechanism – to fully unscrew the legs to change angle (only 2.5 rotations needed)
- Strong legs for reduced 'flex'
- Legs have 6 angle positions for extreme versatility
- Ability to be converted from a standard Ranger Pod leg configuration to a Quad Pod configuration (4 legged tri-pod) by taking the legs from each end and moving them to the middle of the frame through the use of specially supplied shims
- Legs supplied measure 40cm, 45cm & 120cm
- 4 x Karabiner mounting points to tie/weigh down the pod
- Double Cam levers
- Black tubes and framework for extra stability
- All brass threaded fittings (no oxidisation)
- Supplied with carry case that has a full length zip and large front storage pocket
- Perfect for all terrains and venue types including the largest continental lakes and rivers
- 2-rod buzzer bars are available to purchase separately

		*RRP
CRP030	Ranger Mk2 Pod 3-Rod Kit	£299.99
CRP031	Ranger Mk2 Pod 4-Rod Kit	£309.99

FEATURES



Six angle positions on legs for greater flexibility



Double-tube framework for extra stability, which is fully adjustable

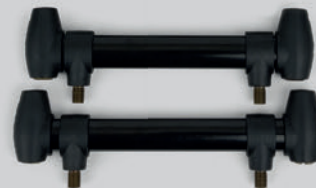

RANGER® MK2 2X BUZZ BARS

		*RRP
CRP032	Ranger Mk2 2-Rod Buzz Bars	£34.99

HORIZON DUO

Includes carry case



HORIZON® DUO POD 3 ROD & 4 ROD

- Twin rail design gives extra stability
- Four leg position angles (allowing for rod tips to be pointing towards sky for long range fishing)
- Double Cam levers
- 2 x Karabiner mounting points to tie/weigh down the pod
- All brass thread fittings (no oxidisation)
- Rubber 'bumper' on 'head' moulding to protect your swinger head once it detaches from line and hits pod
- Standard leg lengths 33cm & 25cm
- 3-rod and 4-rod versions available
- Carry case as standard - incorporating; a full length zip and built-in storage for additional XL legs. Carry case also has snag ear straps so they can be unscrewed from the buzzer bars and stored safely

		*RRP
CRP027	Horizon Duo 3-Rod Pod	£139.99
CRP028	Horizon Duo 4-Rod Pod	£149.99



HORIZON® DUO OPTIONAL EXTRAS

- 2-Rod buzzer bars available separately.
- 36ins XL Legs (to allow the Euro style 'tips up' arrangement)

		*RRP
CRP029	Horizon Duo 2-Rod Buzz Bars	£34.99
CRP033	Horizon Duo 36ins Legs x 2	£29.99



STALKER® + POD

- One of Europe's biggest selling rod pods
- Lightweight aluminium tube frame is ideal for mobile and static angler alike
- Main central body is fully adjustable
- All four legs are extendable to aid the pod's versatility and stability
- Supplied with both 2-rod and 3-rod buzz bars
- Three leg positions - forward, central and back
- Supplied with FREE carry case



Includes carry case

CRP022 Stalker+ Pod *RRP
£99.99



X-POD®+

- Cost-effective pod that is sturdy, reliable and practical
- Scissor-action opening
- Low centre of gravity and goalpost design makes this a very stable set up
- Fox Cam Lok fittings
- Complete with front and rear height adjustable banksticks measuring 30 and 25cm respectively
- Includes a pair of 3-rod Rod Lok buzz bars
- Adjustable length
- Ultra-lightweight and compact design

RP3495 X Pod Plus *RRP
£124.99



A-POD+™

- Based on same design as Stalker Plus pod but without the extending legs and two rod buzz bars
- Ideal for newcomers and anglers on tight budgets that still want Fox quality
- Extendable body
- Lightweight aluminium frame
- Three leg positions
- Supplied with 3-rod buzz bars
- Supplied with FREE carry case

Includes carry case

CRP023 A-Pod + *RRP
£69.99

FEATURES



Easy to adjust cams on the uprights make exact positioning of the buzz bars quick, easy and secure



Handy storage pockets on all 12ft and 13ft Rod Cases



Three different leg positions can be selected - forward, central and back to suit your preference



Goalpost bankstick attachment ensures perfect rod positioning



Length of X-Pod can be adjusted via cam-lock mechanism



Includes protective neoprene case

BLACK LABEL™ COMPLETE 3 ROD POD

- Contains all the items needed to create a fully set up 3-Rod Black Label Compact Rod Pod
- Kit comprises: 1x Compact Pod, 2x 6ins/15cm Cam Lok Banksticks, 2x 9ins/23cm Cam-Lok Banksticks, 1x pair of 3-Rod Fixed Buzz Bars and 1x Conversion Kit
- Perfect for anglers that fish on tough ground
- Supplied in neoprene protective case that stores all components and also features handy zipped compartment for storing bobbins etc

*RRP

CRP035 Complete Pod 3 Rod Kit £179.99

FEATURES



Precision-moulded gears allow for compact pack down



Everything you need to create a 3-Rod Pod



BLACK LABEL™ CAM LOK® BANKSTICKS

- Available in 6ins (15cm), 9ins (23cm), 12ins (30cm), 18ins (45cm), 24ins (60cm) and 36ins (90cm)
- Features Unique Fox Cam-Lok mechanism for strong grip when extended
- Works in conjunction with the new Black Label Compact Pod and all Black Label Buzz Bars
- Fits Black Label Stage Stand and Stabiliser perfectly
- Hardwearing anodised black coating
- Lightweight yet incredibly strong
- Packaging made from 100% recycled cardboard

*RRP

CBS051	6ins/15cm Bankstick	£10.99
CBS041	9ins/23cm Bankstick	£12.99
CBS042	12ins/30cm Bankstick	£14.99
CBS043	18ins/45cm Bankstick	£16.99
CBS044	24ins/60cm Bankstick	£17.99
CBS045	36ins/90cm Bankstick	£19.99



BLACK LABEL™ CAM LOK® POWERPOINT® BANKSTICKS

- Available in 9ins (23cm), 12ins (30cm), 18ins (45cm), 24ins (60cm) and 36ins (90cm)
- Features Cam-Lok mechanism for strong grip when extended
- Supplied with T-bar for extra leverage when screwing into the toughest of ground
- Works in conjunction all Black Label Buzz Bars
- Strong, hard-wearing and sharp Powerpoint spike on end for use on tough ground
- Hard-wearing anodised black coating
- Lightweight yet incredibly strong
- CANNOT be used with Black Label Stage Stand, Stabiliser or Compact Pod
- Packaging made from 100% recycled cardboard

*RRP

CBS046	9ins/23cm	£14.99
CBS047	12ins/30cm	£16.99
CBS048	18ins/45cm	£18.99
CBS049	24ins/60cm	£19.99
CBS050	36ins/90cm	£21.99



BLACK LABEL™ FIXED BUZZ BARS

- Designed to work with Conversion Kit to transform them into goalpost set-up (ideal for Black Label Compact Pod)
- Supplied with hard-wearing leather washer to give good purchase when tightening to bankstick
- Two sizes available: 2-Rod (4.5ins back/5ins front) and 3-Rod (9ins back/10ins front)
- Central screw thread can be removed and replaced with a blanking cap when being used as a goalpost setup
- Packaging made from 100% recycled cardboard

		*RRP
CBB001	Black Label 2-Rod Fixed (Pair)	£29.99
CBB002	Black Label 3-Rod Fixed (Pair)	£34.99
CBB003	Black Label XL-Rod Fixed (Pair)	£39.99



BLACK LABEL™ NARROW FIXED BUZZ BARS

- Narrower version of our best-selling Black Label fixed Buzz Bars allow for a more compact look
- Available in 2-rod and 3-rod models
- Lightweight, anodised black aluminium
- Designed to work with Black Label Conversion Kit to transform them into goalpost (ideal for the Black Label Compact Pod)
- Central screw thread can be removed and replaced with a blanking cap when being used as a goalpost set-up
- Supplied with a hard wearing leather washer to give good purchase when tightening to a bankstick
- Width: 2-rod 3.75in (95mm) rear and 4.3in (110mm) front, 3-rod 7.5in (190mm) rear and 8.6ins (220mm) front

		*RRP
CBB019	Black Label 2-Rod Narrow (Pair)	£29.99
CBB020	Black Label 3-Rod Narrow (Pair)	£36.99



BLACK LABEL™ ADJUSTABLE BUZZ BARS

- Inner tube has a flat side to prevent rotating inside
- Collar and thread adjustment used instead of traditional thumbscrew
- Designed to work with Conversion Kit to transform them into goal post set up (ideal for Black Label Compact Pod)
- Central screw thread can be removed when being used as a goalpost set-up
- Two sizes available: 2-Rod (4.5-6ins back, 5-7ins front) and 3-Rod (6-9ins back/7-10ins front)
- Supplied with hard-wearing leather washer to give good purchase when tightening down to a bankstick
- Packaging made from 100% recycled cardboard

		*RRP
CBB014	Black Label 2-Rod Adjustable (Pair)	£34.99
CBB004	Black Label 3-Rod Adjustable (Pair)	£49.99
CBB009	Black Label XL-Rod Adjustable (Pair)	£49.99

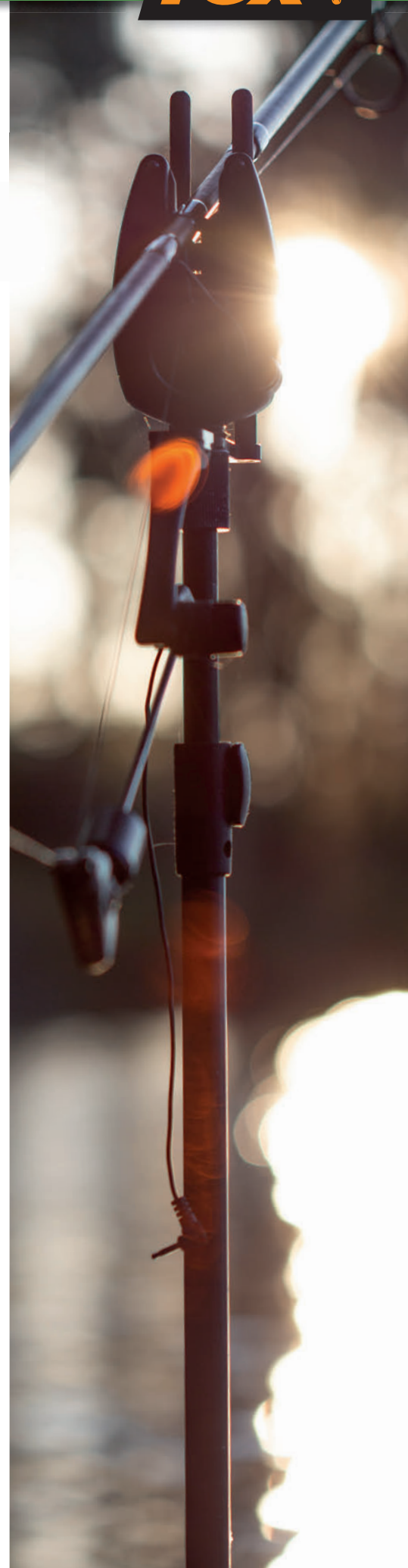



BLACK LABEL™ ANGLE ADAPTOR

- Made from anodized aluminium
- Allows you to change angle of bite alarm or buzz bar, but keep your bankstick straight
- Aids bite indication when fishing with high rod tips
- Perfect for anglers fishing at long range on large lakes and also great for river anglers
- Packaging made from 100% recycled cardboard



BLACK LABEL™ SPACERS

- Designed to give bite alarms increased clearance above Black Label Buzz Bar
- Supplied with three in a pack
- Made from chunky, black anodised aluminium
- Fits all Black Label Buzz Bars
- Packaging made from 100% recycled cardboard

*RRP

CBB018 Angle Adaptor £11.99

*RRP

CBB010 Black Label Spacers x 3 £7.49



BLACK LABEL™ LEATHER WASHERS

- Give good purchase when tightening alarms to a bankstick/buzz bar or when screwing a buzz bar to a bankstick
- Harder wearing than rubber and also less likely to perish or stretch
- Four washers per pack
- Packaging made from 100% recycled cardboard



BLACK LABEL™ CONVERSION KIT

- Designed to transform ALL Black Label buzz bars into goalposts
- Allows Black Label buzz bars and banksticks to work with the new Black Label Compact Pod
- Comprises 4 x threads, 2 x blanking caps and 1 x Allen key
- Packaging made from 100% recycled cardboard

*RRP

CBB006 Black Label Washers £3.99

*RRP

CBB007 Black Label Conversion Kit £6.99

BLACK LABEL™ STABILISER

- Designed to prevent banksticks from spinning in soft ground
- Works with all standard banksticks in Black Label range (not Powerpoint)
- Chunky thumbscrew secure stabiliser to bankstick and also looks the part
- Ideal for soft ground
- Packaging made from 100% recycled cardboard



*RRP

CBS011 Black Label Stabiliser £13.99





BLACK LABEL™ STAGE STAND

- Enables you to fish with banksticks on wooden platforms
- Chunky thumbscrew for securing your bankstick firmly in position
- Screw supplied to secure stand to wood
- Works with Stage Stand Insert, standard Black Label Banksticks and Cam-Lock Black Label sticks (does not work with Powerpoint banksticks)
- Packaging made from 100% recycled cardboard



		*RRP
CBS012	Black Label Stage Stand	£15.99

BLACK LABEL™ STAGE STAND INSERT

- Bins insert that allows your rod tips to be fished as close to water's surface as possible when fishing on wooden platforms
- Works perfectly with Black Label Stage Stand
- Lightweight black anodised aluminium
- Packaging made from 100% recycled cardboard



		*RRP
CBS013	Black Label Stage Stand Insert	£6.49

BLACK LABEL™ LINE GUARDS

- Designed to screw onto banksticks/storm poles to keep mainline safe from weed/debris when continental-style boat angling
- Two models available: C-Guard and Y-Guard
- Y-Guards are used to keep the line out of the water in a straight line, for example over a weedbed or debris in the margins
- C-Guards are used to adjust the angle of line around an obstacle, for example around marginal reeds/rushes, or to create a safer line angle to the rod tip when fishing at extreme angles left or right
- Both feature light reflective strip for easy location with head torch at night



		*RRP
CAC688	C-Line Guard	£10.99
CAC689	Y-Line Guard	£10.99





BLACK LABEL™ HOCKEY STICK SNAG EARS

- Hockey stick built into snag ear plate for easy alarm and indicator alignment
- Designed for Black Label indicators to be screwed onto
- Ears can be unscrewed to protect them in transit or when they are not needed
- Rubber over-moulds on the top half are designed to offer protection to your rod
- Designed to work with most bite alarms, especially our M series of Microns!
- Available in two sizes: standard and XL for fishing with rod tips high
- Packaging made from 100% recycled cardboard

*RRP

CBB011 Black Label Hockey Stick Snag Ears £16.99



BLACK LABEL™ SNAG EAR & ADJUSTABLE HOCKEY STICK

- Machined black anodised plate with integrated adjustable hockey stick
- Adjustable stick allows you to set the tension you require from your bite indicator – simply screw your chosen cord, chain or quiver arm into place to lock the hockey stick in position
- Ears feature rubber overmould that offers protection to your rods
- Ears can be removed for transportation or if not required

*RRP

CBB022 Snag Ear & Adjustable Hockey Stick £19.99



BLACK LABEL™ ADJUSTABLE HOCKEY STICK

- Injection-moulded hard-wearing black plastic
- Adjustable stick allows you to set the tension you require from your bite indicator – simply screw your chosen cord, chain or quiver arm into place to lock the hockey stick in position

*RRP

CBI118 Adjustable Hockey Stick £4.99



BLACK LABEL™ SWINGER® PLATE SNAG EARS

- Built-in Swinger attachment on snag ear plate for easy alarm and Swinger alignment
- Designed for Fox Swingers to slide onto
- Ears can be unscrewed to protect them in transit or when they are not needed
- Rubber over-moulds on the top half are designed to offer protection to your rod
- Designed to work with most bite alarms, especially our N and M series of Microns!
- Available in two sizes: standard and XL for fishing with rod tips high
- Packaging made from 100% recycled cardboard

*RRP

CBB016 Black Label Swinger Plate Snag Ears £17.99

CBB017 Black Label Swinger Plate Snag Ears XL £19.99



BLACK LABEL™ SNAG EARS

- Perfect for preventing rod from coming off alarm when snag fishing
- Ears can be unscrewed to protect them in transit or when they are not needed
- Rubber over-moulds on the top half are designed to offer protection to your rod
- Designed to work with most bite alarms, especially our N and M series of Microns!
- Available in two sizes: standard and XL for fishing with rod tips high
- Packaging made from 100% recycled cardboard

*RRP

CBB005 Black Label Snag Ears £15.99

CBB008 Black Label XL Snag Ears £17.99



BLACK LABEL™ ADJUSTABLE HOCKEY STICK PLATE

- Machined black anodised plate with integrated adjustable hockey stick
- Adjustable stick allows you to set the tension you require from your bite indicator – simply screw your chosen cord, chain or quiver arm into place to lock the hockey stick in position
- Allows current owners of Black Label Snag Ears to upgrade to the adjustable hockey stick with minimal investment

*RRP

CBB021 Adjustable Hockey Stick Plate £13.49



BUTT GRIPS

- Minimalist design
- Designed to be in contact with more of the rod butt's surface area than standard back rests allowing for a firmer grip
- Available in three sizes: Small for standard abbreviated handles, Medium for our Skinny Cork and Skinny Duplon and Large for traditional diameter cork and Duplon handles

		*RRP
CBR001	Small (Abbreviated handles)	£4.25
CBR005	Medium (Skinny Cork/Duplon handles)	£4.25
CBR002	Large (Full handles)	£4.25



BUTT REST

- Similar to our rear 'U' Rod Rest Head but an injection moulded version
- Compact design
- The tight grip is ideal for snag fishing
- Rod is released easily when lifted up

		*RRP
BB2692	Butt Rest	£4.49



DUO GRIP REST

- Injection-moulded plastic rest
- Rubber inlays allow the rods to be locked solid for snag fishing
- Incorporates two betalight slots

		*RRP
BB5133	Duo Grip Rear Rest	£7.49



POWER GRIP BUTT REST

- Spring-loaded butt design gives exceptional grip for snaggy situations when you need to fish 'locked up'
- Simply place the butt of your rod between the two rubber rotating heads and it will lock into position.
- Heads grip the rod perfectly yet cause no damage to the blank

		*RRP
CBR004	Power Grip Butt Grip	£10.99



REAR 'U' ROD REST HEAD

- Compact design that securely grips your rod butt
- The tight grip is ideal for snag fishing
- Rod is released easily when lifted up

		*RRP
BB7392	Rear 'U' Rod Rest Head	£8.49



CAPTIVE BACKLEADS MK2

- Allows angler to use heavy back lead and a tighter line and simply release when rod is lift up
- Mechanical gate latch designed for smooth line release
- Supplied on its own winder with 10m of highly visual orange cord
- Backlead clips onto winder for easy storage
- Winder can be attached to Captive Backlead Bar or pegged to ground via pegging hole

		*RRP
CBW001	1.25oz/35g	£9.99
CBW002	2oz/56g	£9.99
CBW003	3oz/85g	£9.99
CBW004	4oz/113g	£9.99
CBW005	5oz/142g	£10.99



CAM LOK® STORM POLE BANKSTICKS

- Powder-coated aluminium storm poles which are ideal for use with Fox brollies
- Four sizes available
- All models extend to approximately 175% of their original length
- Feature patented Fox Cam Lok® mechanism
- Available in standard point and also Powerpoint® options

		*RRP
CBS019	Cam Lok 48in (120cm)	£14.99
CBS020	Cam Lok 36in (90cm)	£13.99
CBS021	Cam Lok 24in (60cm)	£12.99
CBS022	Cam Lok 16in (40cm)	£11.99
CBS023	Powerpoint® 48in (120cm)	£15.99
CBS024	Powerpoint® 36in (90cm)	£14.99
CBS025	Powerpoint® 24in (60cm)	£13.99
CBS026	Powerpoint® 16in (40cm)	£12.99



CARP CARE

All carp anglers have one thing in one common: a desire and responsibility to ensure that every carp they catch is treated with the utmost respect and care, and that their quarry is returned to its watery home none the worse for its experience.

At Fox we take carp care very seriously, which is why, over the coming pages you'll find what we believe to be the best unhooking mats, nets and slings on the market. The fish we target are getting bigger by the year and so it's essential that our carp care equipment is up to the job of protecting these precious creatures. With us sourcing the very best quality materials and applying extreme attention to detail, you can remain safe in the knowledge that your hard-earned cash is being invested in the very best, when you purchase Fox carp care items.

New for the 2019 catalogue is the Carpmaster Air unhooking mat. Well over a decade ago we launched our original inflatable model and in recent years we've received countless requests to bring back this style of mat. We're pleased now, to be able to offer this style once again in our range. In addition to the mat, we have some new EOS landing nets, designed to complement our entry-level EOS rods. In our opinion, these nets offer unrivalled value for money.

NEW



CARPMASTER® AIR MATS

- Inflatible unhooking mat design for ultimate fish protection
- Two changeable heavy-duty air chambers
- Unlike other inflatable mats on the market, the air valves are positioned in the end of the mat allowing all air to easily push out as the mat is rolled up
- Can be used as a traditional cradle but can also be used flipped upside down
- When used upside down it makes handling very large carp much easier as the one-piece heavy-duty fabric base allows the angler to slide their arms under the fish ensuring complete control
- When used in the upside down position the cover is simply removed from its normal position, repositioned and Velcro-fixed back in place
- Heavy-duty PVC base and tube protection
- 210D polyester fabric styled in unique Fox camo pattern
- Removable 50mm high density foam base

- Pegging points to prevent mat moving in strong winds
- Elasticated and Velcro safety flap
- Polyester carry handles
- Available in two sizes, Standard: 100cm x 50cm and XL: 125cm x 70cm (internal dimensions)
- Supplied with carry bag and foot pump

		*RRP
CCC044	Carpmaster Air Mat	£139.99
CCC045	Carpmaster Air Mat XL	£169.99

Can also be used upside down



Supplied with carry bag and foot pump

FEATURES

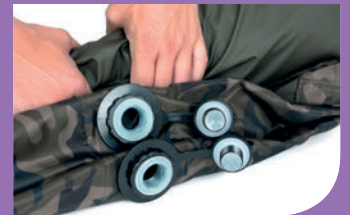

Air valves positioned at end of mat



Pegging points to prevent mat moving



Reinforcements in all of the needed areas



Side carry handles



EASY MAT™

- Revolutionary design that has been copied by many, but never bettered!
- Easy-to-use 'pop-up' frame design enables the mat to be assembled and packed away in a matter of seconds
- Flexible sides help to prevent your catch from flipping/sliding off the mat, yet due to their flexible nature they are fish-safe unlike many of the rigid, metal frame mats on the market
- Extremely well padded base (50mm foam) with fish-friendly finish
- Available in two sizes – Standard and XL

- Both sizes feature reinforced carry straps
- Carry bag supplied as standard
- Compact square shape when packed down makes this design barrow friendly

		*RRP
CCC033	Easy Mat Standard	£74.99
CCC034	Easy Mat XL	£84.99

EASY...



FEATURES



Supplied with handy carry bag



50mm deep padding

Standard Dimensions:

Open size (internal):
L: 108cm x W: 50cm x H: 15cm
Packed size:
L: 52cm x W: 56cm x H: 13cm



XL Dimensions:

Open size (internal):
L: 119cm x W: 66cm x H: 18cm
Packed size:
L: 88cm W: x 60cm x H: 13cm



DELUXE CARPMASTER® UNHOOKING MAT

- Designed to offer unrivalled padding and protection to your catch
- Reinforced, high sides with deep padding that prevent fish from sliding off of mat
- 80mm deep padding on base
- Easy-clean mucus-friendly lining
- Reinforced webbing straps for more even weight distribution when carrying a fish to and from the water in the mat
- Stiffened EVA grab handles
- Zipped pocket on side for carp care kit, forceps and/or weighing scales
- Handy hanging loop for drying mat on bank or at home
- Folds away relatively compact considering depth of padding
- 100% Polyester

		*RRP
CCC029	Delux Carpmaster Cradle	£99.99
CCC031	Deluxe Carpmaster Cradle XL	£124.99

FEATURES

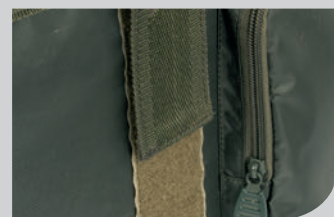

Velcro straps and a handy zipped pocket for storing carp care essentials

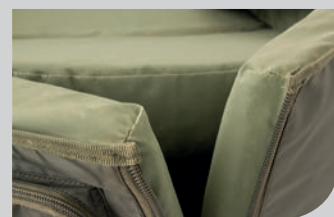

Extra-thick padding with an easy-clean lining, for ultimate protection

Standard Dimensions:

L: 125cm x W: 65cm x H: 28cm

XL Dimensions:

L: 138cm x W: 73cm x H: 28cm



STR FLOATATION WEIGH SLING

- Perfect for weighing your catch as well as retaining it for a short period whilst preparing for photography (STR = Short Term Retention)
- Built around full-length floats, which support a lightweight, fish-friendly, soft nylon and mesh section
- Mesh section designed to maximise water exchange to ensure fish stays healthy
- Top mesh panel allows you to view fish at all times
- Zipped on three sides to allow sling to lay flat on your unhooking mat
- Full-length double zips secured by a dog clip to ensure security
- Sculpted to house and fully support fish centrally during weighing
- Zip baffles to fully protect fish
- Reinforced stitching on all pressure points
- Double grab handles each end for safe lifting and carrying
- 3m heavy-duty sack cord supplied in an external pocket
- Supplied in nylon sleeve / stink bag
- Mesh venting allows rapid water drainage for quick, accurate weighing
- Double weigh-handles with centre-locating loops
- Fox Camo version also available
- 100% Polyester
- Dimensions: L: 124cm x W: 39cm with a drop of 75cm

*RRP

CCC035	Camo STR Floatation Weigh Sling	£59.99
CCC026	STR Weigh Sling	£49.99

FEATURES



Mesh venting allows water to drain rapidly from the sling for accurate weighing



Ideal for retaining your catch for a short time while preparing camera equipment

ROYALE® CARP SACK

- Designed to ensure maximum protection and security when retaining a carp
- Fish-friendly soft mesh
- 4.8m long sack cord
- Single secure zip
- Rounded corners ensure carp cannot get their head trapped
- 100% Polyester
- Dimensions: L: 120cm x W: 80cm

*RRP

CCC032	Royale Carp Sack	£13.99
--------	------------------	--------



SAFETY CARP SACK

- Designed to ensure maximum protection and security when retaining a carp
- External zipped mesh pouch houses a high visibility Fox-moulded H-Block marker (with isotope recesses) on 10m of cord
- Unique sack cord system for enhanced bankstick security with 4m heavy duty cord
- Soft, dark, fish-friendly mesh
- Full length single zip with secure clip fastening
- Rounded corners ensure carp cannot get their head trapped
- Reinforced carry handles
- Supplied in a nylon carry pouch
- Polyester fabric, supplied in a nylon carry pouch
- Dimensions: L: 140cm x W: 100cm

*RRP

CCC027	Safety Carp Sack	£27.99
--------	------------------	--------





WEIGHING TRIPOD

- Ideally suited to anglers that fish alone or need to weigh very large fish where extra support is needed to attain an accurate weight
- Two-piece legs with spigot in the middle to stop the legs from slipping under pressure from heavy fish
- Wide footprint aids stability
- Made from top quality, hard-wearing steel frame
- Comes supplied with own carry bag

CCC037 Weighing Tripod *RRP £39.99



WEIGH BAR & CASE

- Dual purpose
- Bar comprises of 3 parts – two handle sections and the 'hook' section
- The two handles screw together with hook in middle
- The bar can be used as a standard weigh-bar for weighing fish or you can screw a pole onto the thread of the 'hook' section to create a weigh-crook instead
- All three parts pack away into the neoprene carry case that is supplied

CCC036 Weigh Bar inc Case *RRP £22.99



DIGITAL SCALES

- Compact design
- Very user-friendly
- Simple, easy-to-use buttons
- Features on/off button to ensure maximum battery life
- Independently-sealed electronics
- Simple zero button (0.00) which you press once you have attached your wet weigh sling
- Simply press the kg/lb button to select between kilograms and pounds
- Backlit screen for easy use in the dark
- Metal loop on top for use with a weigh-bar or crook, or simply use your thumb for small fish
- Large weighing hook so easy to place weigh-sling on it
- Low battery indicator
- Weighs up to 60kg (132lb) in 1oz increments
- Supplied with protective PU hard case
- Takes 2 x AA batteries

CEI155 Digital Scales 60kg inc Case *RRP £99.99

FEATURES



Folds up for easier transportation



Large weighing hook so easy to place weigh sling on it

FEATURES



Back lit screen for use in the dark



Simple, easy to use buttons

COLLAPSIBLE WATER BUCKET

- Perfect for keeping your catch wet when on the unhooking mat
- Welded PVC construction
- Collapsible design for compact storage
- Rigid top ring for easy filling
- 4.5 litre capacity
- Removable 1.6m drop cord with clip to aid filling when on high banks or if you suffer from a bad back
- Can also be used for cleaning hands, mixing groundbait etc



CCC040 Collapsible Water Bucket *RRP
£8.99

FEATURES



Perfect for keeping your catch wet on the bank



Collapsible design for compact storage

CAMOLITE™ NET FLOAT

- Features unique Fox Camo pattern
- Design to aid landing of fish
- Split design enables float to be used on nets with fixed spreader block such as Torque and Horizon XT
- Velcro closing and fastening



CLN035 Camolite Net Float *RRP
£9.99



FEATURES



Split design enables float to be used on nets with fixed spreader block



Easy fixing

FX NET STINK SLEEVE

- Available in standard and XL
- Fully-welded seams to retain water and unpleasant smell
- Standard is designed to fit either a 42, 46 or 50ins landing net
- XL can hold two 42, 46 or 50ins landing nets or one of our STR Weigh Slings and a landing net
- Both feature a handy external pocket and Velcro strap for storing landing net pole, or even a stalking rod

		*RRP
CLU256	FX Net Stink Bag Sleeve	£12.99
CLU266	FX Net Stink Bag Sleeve XL	£16.99



HORIZON^{XT}

HORIZON[®] XT LANDING NET

- No expense spared on this top-of-the range landing net
- Highly versatile
- Unique spigoted-handle design
- Complements the Horizon XT rod range
- Supplied with 6ft and 3ft handle options – 6ft for everyday use whilst 3ft is perfect for boat use
- The 3ft handle can also be added to 6ft one to create a 9ft handle for landing fish on Zig Rigs or from high swims
- Features a 1k carbon weave
- Japanese shrink wrap handle grip
- Black fittings
- Moulded solid aluminium spreader block that is bonded to a 6ins spigot and features a betalight slot
- Carbon arms
- The deep mesh is reinforced on the corners, is incredibly soft and a nice carpy green colour
- Supplied with net bag
- Available in either 42 or 46ins

		*RRP
CLN027	Horizon XT 42" Landing Net	£189.99
CLN028	Horizon XT 46" Landing Net	£199.99

FEATURES



Soft mesh with reinforced corners



Machined aluminium spreader block

TORQUE

TORQUE[®] LANDING NET

- Designed to match the Torque rod range
- Offers outstanding value for money
- One of the best-selling landing net ranges on the market
- Very light and easy to manoeuvre in the water
- 6ft and 8ft handle options available
- 8ft version features a two-piece handle that is ideal for boat fishing
- Japanese shrink wrap handle grip
- Moulded solid aluminium spreader block with a beta-light slot
- Carbon arms
- The deep mesh is reinforced on the corners, is incredibly soft and a nice green colour
- Supplied with net bag
- 6ft model available in either 42 or 46ins, 8ft version available 42ins



		*RRP
CLN025	Torque 42" Landing Net	£99.99
CLN026	Torque 46" Landing Net	£104.99
CLN032	Torque 42" 8ft 2 Piece Landing Net	£109.99



SPARE REINFORCED MESH

- Soft green mesh
- Reinforced corner sections
- Designed to fit both Horizon XT and Torque models

		*RRP
CLN030	42" Landing Net Mesh	£19.99
CLN031	46" Landing Net Mesh	£22.99

NEW

EOS



6ft one piece handle

EOS® LANDING NET

- 6ft one piece matt black carbon handle
- Die-cast aluminium spreader block
- Shallow 70cm soft mesh
- Supplied with net bag
- Complements EOS rods
- Available in 42ins and 46ins

		*RRP
CLN036	EOS 42" Landing Net	£49.99
CLN037	EOS 46" Landing Net	£59.99
CLN039	EOS 42" Mesh/Cord	£15.99
CLN040	EOS 46" Mesh/Cord	£16.99

FEATURES



Complements the EOS rod range



70cm soft mesh



Die-cast aluminium spreader block



6ft two-piece handle

EOS® COMPACT LANDING NET

- 42ins arms with a 6ft two-piece matt black carbon handle
- Ideal for creating a shorter handle for landing fish from rowing boats
- Die-cast aluminium spreader block
- Shallow 70cm soft mesh
- Supplied with net bag
- Complements EOS rods

		*RRP
CLN038	EOS 42" Compact Landing Net	£59.99

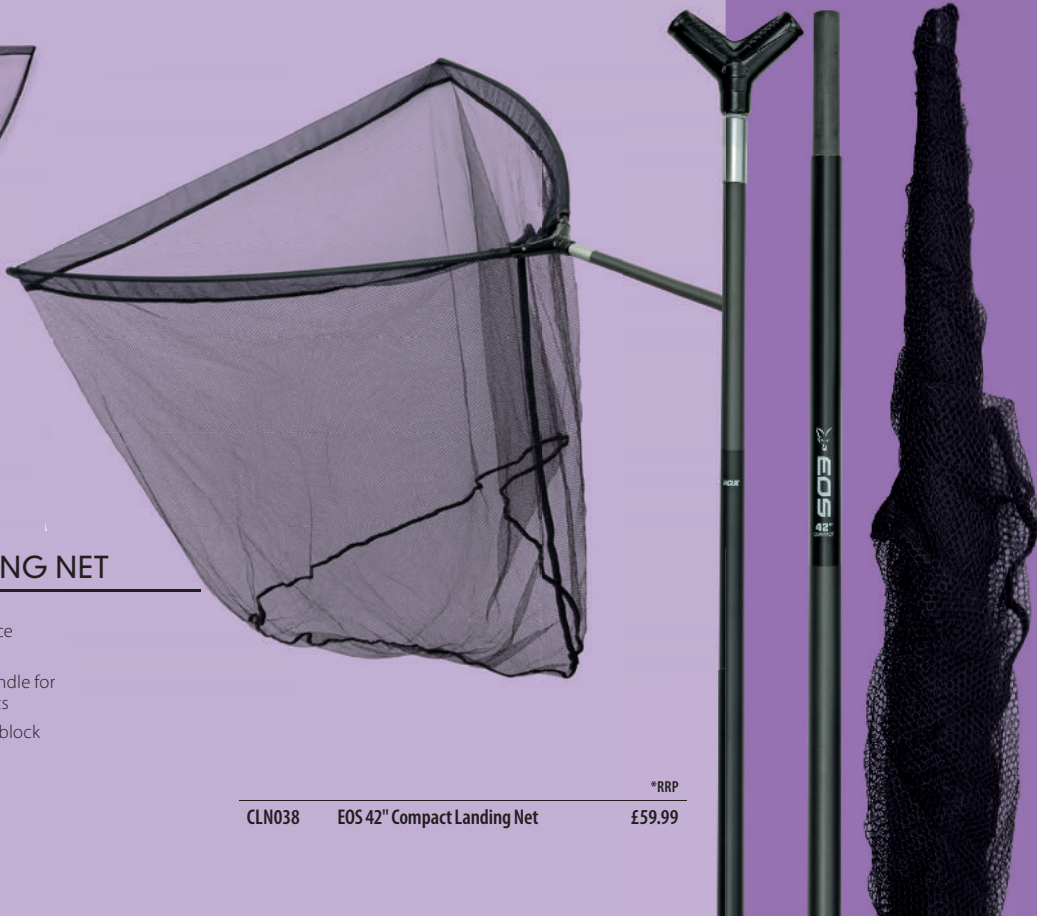



TACKLE & RIG STORAGE

It's no surprise that the vast majority of Europe's most successful carp anglers are incredibly well organised. In a world where there are more carp anglers on the bank than ever before, it's vitally important to be organised and to pay attention to the finer details if you wish to be more successful than your peers.

In the early days of carp fishing, anglers did not have access to dedicated rig and storage devices. Instead, they improvised, or made their own. Our founder, Cliff Fox, quickly recognised the inherent need for purpose-designed storage systems for carp fishing. We've been making market-leading storage systems for several decades now.

New for 2019 are our F Box Magnetic Rig Box Systems. These feature a number of innovations that we firmly believe take rig storage to a whole new level. We retain many of our existing high-end storage products, including the F Box Hook Storage Cases, Zig Discs, and the F Box and Royale Tackle Boxes.

NEW



Rigs not included

F BOX® MAGNETIC DOUBLE RIG BOX SYSTEM – LARGE

- Part of a new innovative, interchangeable rig storage solution
- Comprises 2 x large double-ended rig boards
- High-density EVA foam ensures rig pins stay securely in place
- Profiled hook bars at both ends of each board to stop rigs from sliding and bunching together
- Magnetic hinges allow the two boards to be separated from one another
- Compatible with the F-Box Magnetic Large Rig Box Lids
- Magnets ensure firm closure
- Moulded ruler on outside allows for accurate rig tying
- Supplied with 60 pins

*RRP

CBX080 Large Rig Box System £24.99



F BOX® MAGNETIC DISC & RIG BOX SYSTEM – LARGE

- Part of a new innovative, interchangeable rig storage solution
- Comprises 1 x large double-ended rig board and 1 x large magnetic Chod Disc and boom storage board
- Supplied with 2 x Short Chod Discs and 4 x Standard Chod Discs
- Supplied discs have designated areas on them for users to write the hook size, type and hooklink breaking strain on
- Comes with 6 magnetic disc inserts that are placed into the centre of a Chod Disc to then fix the disc inside the Rig Box
- Anglers can remove the supplied Chod Discs and replace with the Edges Ready Tied Chod Rig discs
- High-density EVA foam on rig board ensures rig pins stay securely in place
- Profiled hook bars at both ends of the rig board stop rigs from sliding and bunching together
- Boom storage features small, moulded hooks for holding one loop or swivel end of boom section – other end then pinned in place on the board
- Magnetic hinges allow the two boards to be separated from one another
- Compatible with the F-Box Magnetic Large Rig Box Lids
- Magnets ensure firm closure
- Moulded ruler on outside allows for accurate rig tying
- Supplied with 60 pins

*RRP

CBX081 Large Disc & Rig Box System £29.99

FEATURES



Magnetic disc inserts to secure the disc in place



Magnetic hinges allow the two boards to be separated from one another



Boom storage on section on the large Disc & Rig Box System

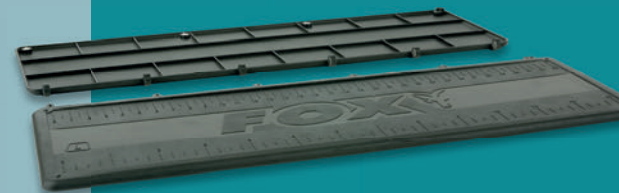

F BOX® MAGNETIC RIG BOX LIDS – LARGE

- Low profile lids that are compatible with the F-Box Magnetic Large Rig Box Systems
- User simply detaches the two halves of either of the Large Rig Box Systems and then attaches the lids to each half via the magnetic hinges
- Helps to create even more compact rig storage
- Magnets ensure firm closure
- Moulded ruler on outside allows for accurate rig tying
- Two lids per pack

*RRP

CBX083 Rig Box System Lids Large x2 £12.99

NEW



Rigs not included

F BOX® MAGNETIC DOUBLE RIG BOX SYSTEM – MEDIUM

- Part of a new innovative, interchangeable rig storage solution
- Comprises 2 x medium rig boards
- High-density EVA foam ensures rig pins stay securely in place
- Profiled hook bars stop rigs from sliding and bunching together
- Magnetic hinges allow the two boards to be separated from one another
- Compatible with the F-Box Magnetic Medium Rig Box Lids
- Magnets ensure firm closure
- Moulded ruler on outside allows for accurate rig tying
- Supplied with 50 pins

CBX078 Medium Rig Box System *RRP
£19.99



F BOX® MAGNETIC DISC & RIG BOX SYSTEM – MEDIUM

- Part of a new innovative, interchangeable rig storage solution
- Comprises 1 x medium rig board and 1 x medium magnetic Chod disc storage board
- Supplied with 2 x Short Chod Discs and 6 x Standard Chod Discs
- Supplied discs have designated areas on them for users to write the hook size, type and hooklink breaking strain on
- Comes with 10 magnetic disc inserts that are placed into the centre of a Chod Disc to then fix the disc inside the Rig Box
- Anglers can remove the supplied Chod Discs and replace with the Edges Ready Tied Chod Rig discs
- High-density EVA foam on rig board ensures rig pins stay securely in place
- Profiled hook bars on rig board stop rigs from sliding and bunching together
- Magnetic hinges allow the two boards to be separated from one another
- Compatible with the F-Box Magnetic Medium Rig Box Lids
- Magnets ensure firm closure
- Moulded ruler on outside allows for accurate rig tying
- Supplied with 50 pins

CBX079 Medium Disc & Rig Box System *RRP
£24.99

FEATURES



Adding the lid reduces depth considerably

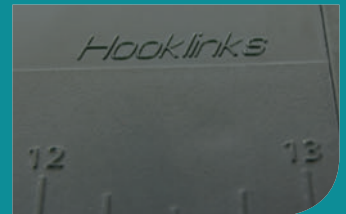

Moulded ruler on outside for accurate rig tying



Profiled hook bars prevent rigs from bunching together

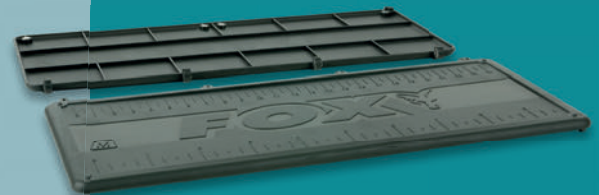

F BOX® MAGNETIC RIG BOX LIDS – MEDIUM

- Low profile lids that are compatible with the F-Box Magnetic Medium Rig Box Systems
- User simply detaches the two halves of either of the Medium Rig Box Systems and then attaches the lids to each half via the magnetic hinges
- Helps to create even more compact rig storage
- Magnets ensure firm closure
- Moulded ruler on outside allows for accurate rig tying
- Two lids per pack

CBX082 Rig Box System Lids Medium x2 *RRP
£10.99



Rigs not included

ZIG DISC

- Purposely designed for Zig Rig storage
- Also ideal for surface fishing hooklinks
- Supplied with five, removable High-density foam discs
- Discs can be removed from the central bar and have a circumference of 1ft (30cm), which makes it very easy to tie the perfect length Zig every time
- Supplied with 20 rig pins which are stored in the handle
- Comes supplied in a handy neoprene zip case that keeps your rigs protected in transit

CAC498 Zig Disc Storage System *RRP £17.99

STEAM AND STORE CHOD/WITHY BIN

- Purposely designed for aiding the tying and storing of Chod and Withy Pool rigs
- Self-contained within a compact and secure screw-topped and tinted green storage tub
- Features three different diameter sections that allow you to select the degree of curve that best suits you
- Simply place your Chod or Withy Pool Rig on your chosen section and then steam it over a boiling kettle to help set the perfect curve
- Rigs can be stored on device until they are needed
- Supplied with 20 specially designed pins that allow you to put stiff rig loops under tension without them losing their shape



CAC377 Steam and Store Chod/Withy Bin *RRP £16.99

MULTI CHOD & ZIG BIN

- Purposely designed for storage of Chod and Zig Rigs
- Also helps you when tying Chod and Zig Rigs
- Supplied with six discs in total – two of each size
- Largest disc is perfect for storing Zig Rigs, also helps to measure the length as 1 wrap is 1/2ft therefore 2 wraps of the disc = 1ft
- The discs can be removed from the main shaft and further discs are available to purchase separately meaning you can customise the bin to have the sizes of disc you prefer
- Can also be used to help steam the perfect curve in your Chod Rigs too
- Supplied with 18 pins
- Discs also available separately – two discs per packet + 6 pins per packet



CAC656 Multi Chod and Zig Bin inc. 18 pins *RRP £10.99
 CAC657 Chod Disc Small inc 6 pins x 2 £3.49
 CAC658 Chod Disc Medium inc 6 pins x 2 £3.49
 CAC659 Chod Disc Large inc 6 pins x 2 £3.49

HOW THE ZIG DISC WORKS...

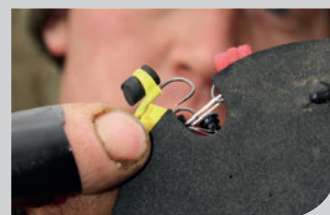

Start by placing your hook into the foam groove on a Zig Disc

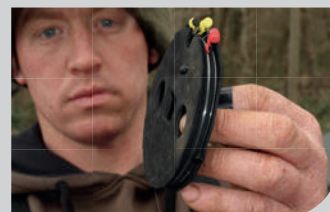

Now wind the hooklink around the disc – every wrap is 1ft

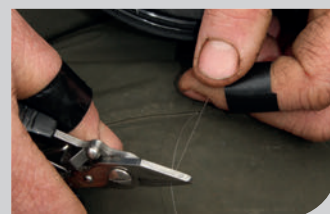

When you have your desired length simply cut the hooklink



Tie a figure-of-eight loop in the end and pin the hooklink in place



Hooks not included

F BOX® HOOK STORAGE

- Purpose-designed storage system for keeping your hooks protected and organised
- Moulded rubber insert holds each hook individually to ensure the point cannot be damaged in transit
- Supplied with self-adhesive identification labels that allow you to record pattern and size of hooks inside
- Designed to fit neatly inside F-Box and Royale tackle boxes
- Will accommodate hooks from size 2-10
- Two sizes available:
Large (holds 18 hooks) and XL (holds 29 hooks)
- Two boxes per pack

		*RRP
CBX075	Hook Storage Cases Large x2	£6.99
CBX076	Hook Storage Cases XL x2	£7.99

FEATURES



Handy self-adhesive labels for easy identification



Moulded rubber insert holds hooks individually



ROYALE® SYSTEM BOX

- Perfect for storing your rig and accessory items
- Removable dividers allow you to change size of compartments
- Medium supplied with: 4 Compartment Box, 2 Compartment Box, 4 x Flip Top 4 Compartment Box, Rig Board and Spool Dispenser
- Large supplied with: 8 Compartment Box, 2 Compartment Box, 4 Compartment Box x2, Flip Top 4 Compartment Box x4, Rig Board, Spool Dispenser x2
- Styled in a carpy green
- Designed to fit Royale, Camolite and FX luggage

		*RRP
CBX067	Royale Loaded Box Medium	£29.99
CBX068	Royale Loaded Box Large	£39.99



F BOX® & DELUXE F BOX



The ultimate in ready-made storage solutions F Box Deluxe boxes are supplied with a variety of different F Boxes and spool dispensers so you have a comprehensive storage system to accommodate all of your tackle items.

The whole range is also totally integrated with our highly popular R Series, Camolite and Voyager luggage ranges so you can be sure you'll find the perfect pocket to put them in to get them safely to your swim too. F Boxes include all of the same features as the F Box Deluxe, but are supplied without additional storage boxes so you can tailor storage to your own individual requirements.

F BOX® LARGE DOUBLE

- Deep partition large x4
- Deep partition medium x4
- Deep partition small x8
- Shallow partition large x4
- Shallow partition medium x4
- Shallow partition small x4

*RRP

CBX005 F Box Double Large Box £39.99



F BOX® MEDIUM DOUBLE

- Deep partition large x4
- Deep partition medium x3
- Deep partition small x3
- Shallow partition large x4
- Shallow partition small x4

*RRP

CBX006 F Box Double Medium Box £34.99



F BOX® LARGE SINGLE

- Deep partition large x4
- Deep partition medium x4
- Deep partition small x8

*RRP

CBX007 F Box Large Box £34.99



F BOX® MEDIUM SINGLE

- Deep partition large x4
- Deep partition medium x3
- Deep partition small x3

*RRP

CBX008 F Box Medium Box £22.99

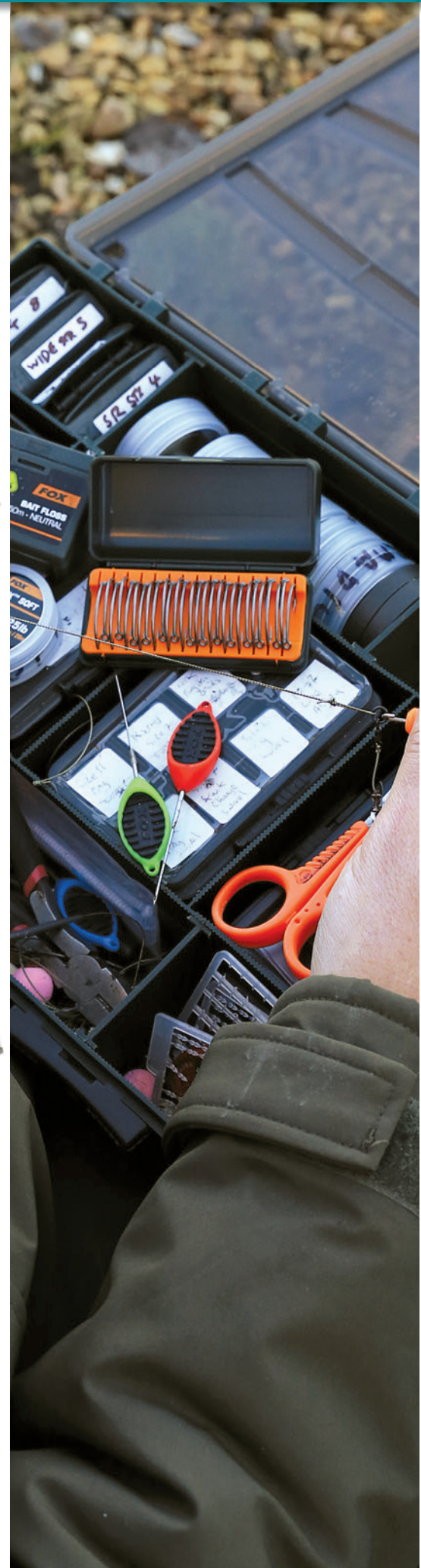



F BOX® DELUXE LARGE DOUBLE

- Deep partition large x 4
- Deep partition small x 8
- Shallow partition medium x 4
- 8 compartment x 2
- 2 compartment x 1
- 4 compartment shallow x 1
- Rig boards x 2
- Deep partition medium x 4
- Shallow partition large x 4
- Shallow partition small x 4
- 4 compartment x 1
- 8 compartment shallow x 1
- Spool dispensers x 5
- Flip top x 2



*RRP
CBX001 F Box Deluxe Set - Large Double £84.99

F BOX® DELUXE MEDIUM DOUBLE

- Deep partition large x 4
- Deep partition small x 3
- Shallow partition small x 4
- 6 compartment x 1
- 8 compartment shallow x 1
- Spool dispensers x 2
- Deep partition medium x 3
- Shallow partition large x 4
- 8 compartment x 1
- 4 compartment x 1
- 4 compartment shallow x 1
- Flip top x 2



*RRP
CBX002 F Box Deluxe Set - Medium Double £64.99

F BOX® DELUXE LARGE SINGLE

- Deep partition large x 4
- Deep partition small x 8
- 4 compartment x 1
- Spool dispensers x 5
- Flip top x 2
- Deep partition medium x 4
- 8 compartment x 2
- 2 compartment



*RRP
CBX003 F Box Deluxe Set - Large Single £74.99

F BOX® DELUXE MEDIUM SINGLE

- Deep partition large x 4
- Deep partition small x 3
- 4 compartment x 1
- Flip top x 2
- Deep partition medium x 3
- 8 compartment x 1
- Spool dispensers x 2



*RRP
CBX004 F Box Deluxe Set - Medium Single £44.99



8 Compartment



6 Compartment



4 Compartment

F BOX® COMPARTMENT BOXES

- Perfect for storing a whole variety of rig bits including swivels, beads, clips, boillie stops, sinkers, Zig Alignas, foam, cork, Line Alignas etc
- Modular design
- Fits perfectly into F Box and Royale tackle boxes
- Contents remain visible
- Secure clips
- Easy to remove contents
- Available in 8, 6, 4 and 2 compartment options

		*RRP
CBX015	F Box 2 Compartment	£7.49
CBX011	F Box 4 Compartment	£7.49
CBX028	F Box 6 Compartment	£7.49
CBX009	F Box 8 Compartment	£7.49



ACCESSORIES

The Fox range of accessories is as comprehensive as any you're likely to find on the market. No stone's been left unturned by our product development team who've worked tirelessly, to not only ensure the range is far reaching, but also the best available to help our loyal customers catch as many fish as possible. We are fortunate in having a very large product development team spread across Europe. This allows us to design products not just for the UK market, but also to be able to produce a range that caters for all styles of carp fishing across the globe.

Since its launch, the Edges range of terminal tackle has taken the world by storm and has helped anglers of all abilities become more successful. The range has grown year on year and 2019 is no different, with several additions, including the new Fused Fluorocarbon leaders, a whole new range of Camo Submerge lead-free leader products and an extensive PVA range to name but a few.

As well as the Edges range, you'll also find a number of other accessories, such as leads, floats (Zigs, H-Block and Marker) and baiting tools - we've included a number of new baiting spoon designs in our detailed baiting tool range.



CURVE SHORT RIGS

- Constructed from Edges Coretex Matt coated braid with loop in end for use with quick change swivels
- Featuring Edges Curve Short hooks
- Breaking strain matches hook size: 15lb (6.8kg) with size 8 hook, 20lb (9.07kg) in size 6 and 25lb (11.3kg) for size 4 and 2
- Also feature Trans Khaki Anti-Tangle Sleeves, Trans Khaki Line Aligna Adaptor and Trans Khaki Hook Silicone on Hair
- Supplied with 2 x size 7 Swivels, 2 x size 7 Kwik Change Swivels and FREE Hair Extending Boilie Props
- 2 rigs per packet
- Micro Barbed-only
- Available in Weedy Green or Gravelly Brown



WIDE GAPE RIGS

- Constructed from Edges Coretex Matt coated braid with loop in end for use with quick change swivels
- Featuring Edges Wide Gape Beaked hooks
- Breaking strain matches hook size: 15lb (6.8kg) with size 8 hook, 20lb (9.07kg) in size 6 and 25lb (11.3kg) for size 4 and 2
- Also feature Trans Khaki Anti-Tangle Sleeves, Trans Khaki Line Aligna Adaptor and Trans Khaki Hook Silicone on Hair
- Supplied with 2 x size 7 Swivels, 2 x size 7 Kwik Change Swivels and FREE Hair Extending Boilie Props
- 2 rigs per packet
- Micro Barbed and Barbless options available (Barbless only available in hook sizes 6 and 8)
- Available in Weedy Green or Gravelly Brown



WIDE GAPE PVA BAG RIGS

- Constructed from Edges Reflex Camo Braid in Light Camo with a loop in end for use with quick change swivels
- Featuring Edges Wide Gape Beaked hooks
- Breaking strain matches hook size: 15lb (6.8kg) with size 6 and 8 hook, 25lb (11.3kg) for size 4
- Also feature Trans Khaki Micro Line Aligna Adaptor and Trans Khaki Hook Silicone on Hair
- Supplied with 2 x size 7 Flexi Ring Swivels, 2 x size 7 Kwik Change Swivels, 2 x Trans Khaki Micro Anti-Tangle Sleeves and FREE Hair Extending Boilie Props
- 2 rigs per packet
- Micro Barbed and Barbless options available (Barbless only available in hook sizes 6 and 8)



CHOD RIGS

- Constructed from Edges Rigidity Trans Khaki stiff monofilament
- Featuring Edges Stiff-rig Beaked hooks
- Breaking strain matches hook size: 25lb (11.3kg) for sizes 6, 7 and 8 and 30lb (13.6kg) for sizes 4 and 5
- Also feature Edges Micro Hook Ring Swivel on the D for mounting hookbait onto and a size 11 Flexi Ring Swivel
- Supplied on foam discs that can be loaded straight into your Multi Chod & Zig Bin
- 3 rigs per packet
- Micro Barbed and Barbless options available (Barbless only available in hook sizes 6 and 8)
- Available in Standard and Short sizes

NEW



SUBMERGE® CAMO LEADER HELI RIGS KWIK CHANGE

- 3 x 75cm lengths of pre-spliced Submerge Camo lead-free leader
- All three leaders have Edges Trans Khaki rig components in place creating the ideal helicopter set-up
- Supplied with: 3 x Heli Buffer Sleeves, 3 x Tapered Bore Beads, 3 x 0.5mm Leader Silicone, 3 x Size 7 Heli Swivel, 3 x Micro Speed Links and 3 x Micro Anti Tangle Sleeves
- Available in both 30lb and 40lb breaking strains

CAC711 Submerge Camo Heli Rigs K/C 30lb Kit

CAC712 Submerge Camo Heli Rigs K/C 40lb Kit



SUBMERGE® CAMO LEADER LEAD CLIP KWIK CHANGE

- 3 x 75cm lengths of pre-spliced Submerge Camo lead-free leader
- All three leaders have Edges Trans Khaki rig components set up in place creating the ideal lead clip set-up
- Supplied with Power Grip Tail Rubbers, size 7 Safety Lead Clips, Micro Anti Tangle Sleeves and size 7 Kwik Change Swivels
- Available in both 30lb and 40lb breaking strains

CAC709 Submerge Camo Lead Clip K/C 30lb Kit

CAC710 Submerge Camo Lead Clip K/C 40lb Kit



SUBMERGE® CAMO LEADER KWIK CHANGE 30LB

- 3 x 75cm lengths of pre-spliced 30lb Submerge Camo lead-free leader
- Supplied with a size 7 Kwik Change Swivel and 3 Micro Anti-Tangle sleeves

CAC713 Submerge Camo Kwik Change 30lb Kit



SUBMERGE® CAMO LEADER KWIK CHANGE 40LB

- 3 x 75cm lengths of pre-spliced 40lb Submerge Camo lead-free leader
- Supplied with a size 7 Kwik Change Swivel and 3 Micro Anti-Tangle sleeves

CAC714 Submerge Camo Kwik Change 40lb Kit





NEW



LEADCORE HELI RIGS + K/C KIT

- Three 75cm lengths of Edges Camo Leadcore
- All three leaders have Edges Trans Khaki helicopter rig components set up in place
- Features 3 x Heli Buffer Sleeves, 3 x 6mm Tapered Bore Bead, 3 x length 0.5mm Leader Silicone
- Supplied with 3 x Flexi Ring
- Swivel plus 3 x Kwik Change Flexi Ring Swivels
- Spliced loops at both ends so swivels can be changed via simple loop-to-loop connection
- Allows you to connect via loop-to-loop straight to the swivel on one of our ready-tied rigs
- Available in Light or Dark Camo

CAC573	Leadcore Heli Rigs + KC Kit Light Camo
CAC574	Leadcore Heli Rigs + KC Kit Dark Camo



LEAD CLIP LEADCORE LEADERS + K/C KIT

- Three 75cm lengths of Edges Camo Leadcore
- All three leaders have Trans Khaki Lead Clip and Tail Rubber in place
- Supplied with standard and Kwik Change swivel options
- Spliced loops at both ends so swivels can be changed via simple loop-to-loop connection
- Allows you to connect via loop-to-loop straight to the swivel on one of our ready-tied rigs
- Available in Light or Dark Camo

CAC575	Lead Clip Leadcore Leaders + KC Kit Light Camo
CAC576	Lead Clip Leadcore Leaders + KC Kit Dark Camo



LEADCORE LEADERS + K/C KIT

- Three 75cm lengths of Edges Camo Leadcore
- Supplied with three swivel options – standard, Flexi Ring and Kwik Change
- Spliced loops at both ends so swivels can be changed via simple loop-to-loop connection
- Allows you to connect via loop-to-loop straight to the swivel on one of our ready-tied rigs
- Available in Light or Dark Camo

CAC577	Leadcore Leaders + KC Kit Light Camo
CAC578	Leadcore Leaders + KC Kit Dark Camo



LEAD CLIP TUBING RIGS + K/C KIT

- Three 75cm lengths of Edges Camo Leadcore
- Supplied with three swivel options – standard, Flexi Ring and Kwik Change
- Spliced loops at both ends so swivels can be changed via simple loop-to-loop connection
- Allows you to connect via loop-to-loop straight to the swivel on one of our ready-tied rigs
- Available in Light or Dark Camo

CAC579	Lead Clip Tubing Rigs + KC Kit - Trans Khaki
--------	--



FLUOROCARBON FUSED LEADERS KWIK CHANGE

- Fused Fluorocarbon leader with a clear plastic outer coating
- Supplied with Edges Kwik Change Swivel
- 30lb breaking strain
- Non-glare, anti-spook finish
- Two swivel size options available size 7 and 10
- Available in two lengths: 75cm and 115cm

CAC694	30lb 75cm Kwik Change Size 7	
CAC695	30lb 75cm Kwik Change Size 10	
CAC717	30lb 115cm Kwik Change Size 7	NEW
CAC718	30lb 115cm Kwik Change Size 10	NEW



FLUOROCARBON FUSED LEADERS

- Fused Fluorocarbon leader with a clear plastic outer coating
- Fused loops at each end allow the leader to be used for helicopter, running and inline lead presentations - simply thread on chosen rig components and then loop the desired swivel to the end
- 30lb breaking strain
- Non-glare, anti-spook finish
- Available in two lengths: 75cm and 115cm

CAC719	30lb 75cm Multi Purpose
CAC720	30lb 115cm Multi Purpose



EDGES® CURVE SHANK

- Improved version of the original Arma Point SSC design
- Especially suited to bottom-bait and wafter presentations
- Needle-sharp straight point
- Inturned eye
- Aggressive curved shank helps the hook to turn and grab hold in the fish's mouth
- Barbed sizes available: 2, 4, 5, 6, 7 & 8
- Barbless size available: 6 & 8



EDGES® CURVE SHORT

- Improved version of the original Arma Point XSC design
- Perfect for both bottom-bait and pop-up presentations
- Needle-sharp straight point
- Straight eye
- Short, sweeping shank
- Only available in Barbed
- Sizes available: 2, 4, 5, 6, 7 & 8

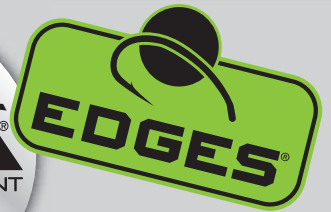

HOOK FEATURES

- ✓ Utilizes Arma Point technology
- ✓ Super-strong yet lightweight XC80 Vanadium forged steel construction
- ✓ Non-reflective dark coating
- ✓ 10 hooks per packet

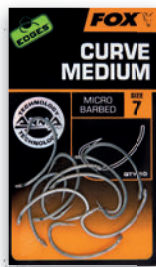

EDGES® CURVE MEDIUM

- Perfect for both bottom-bait and pop-up presentations
- Ideally suited for the popular 360 Rig presentation
- Needle-sharp straight point
- Inturned eye
- Aggressive medium-length curved shank helps the hook to turn and grab hold in the fish's mouth
- Barbed sizes available: 2, 4, 5, 6, 7 & 8
- Barbless size available: 6 & 8

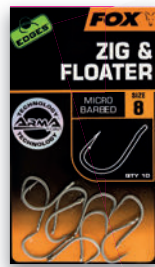

EDGES® ZIG & FLOATER

- Designed specifically for use on Zig and surface rigs
- Also suited to bottom-bait stiff-rig presentations when scaling down is required
- Needle-sharp straight point
- Slightly outturned eye for use with monofilament hooklinks
- Finer wire gage compared to other Edges hooks for the delicate presentations
- Barbed sizes available: 6, 8 & 10
- Barbless size available: 6, 8 & 10



EDGES® WIDE GAPE BEAKED

- Improved version of the original Arma Point SSBP design
- Perfect for both bottom-bait and pop-up presentations
- Needle-sharp beaked point
- Beaked point makes hook perfect for bottom-bait fishing on hard gravel lakebeds
- 10 degree inturned eye
- Barbed sizes available: 2, 4, 5, 6, 7 & 8
- Barbless size available: 6 & 8

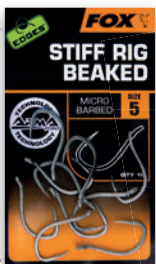

EDGES® STIFF-RIG BEAKED

- Improved version of the original Arma Point SR design
- Perfect for pop-up presentations such as Chod, Hinged Stiff and Multi rigs
- Also suited to bottom-bait stiff-rig presentations
- Needle-sharp beaked point
- 25 degree outturned eye for use with super-stiff mono such as Edges Rigidity
- Large eye allows 30lb Rigidity to pass through three times if attaching with knotless knot
- Barbed sizes available: 2, 4, 5, 6, 7 & 8
- Barbless size available: 6



EDGES® STIFF-RIG STRAIGHT

- Designed to meet the demands of anglers that prefer straight pointed hooks
- Perfect for pop-up presentations such as Chod, Hinged Stiff and Multi rigs
- Also suited to bottom-bait stiff-rig presentations
- Needle-sharp straight point
- 25 degree outturned eye for use with super-stiff mono such as Edges Rigidity
- Large eye allows 30lb Rigidity to pass through three times if attaching with knotless knot
- Barbed sizes available: 2, 4, 5, 6, 7 & 8
- Barbless size available: 6 & 8



EDGES® WIDE GAPE STRAIGHT

- Perfect for both bottom-bait and pop-up presentations
- Long, needle-sharp straight point
- Aggressive 25 degree inturned eye
- Barbed sizes available: 2, 4, 5, 6, 7 & 8
- Barbless size available: 6 & 8



CORETEX™ MATT

- Based on original Coretex but with an improved matt coating to reduce glare in water
- Perfect for a wide variety of rig presentations
- Semi-stiff coating aids anti-tangle properties and allows for combi rig presentations to be created
- Easy-to-strip outer coating
- Available in Weedy Green and Gravelly Brown
- Breaking strains: 15lb (6.8kg), 20lb (9kg), 25lb (11.3kg) and 35lb (15.8kg)
- 20m on a spool



CAMOTEX™ SOFT

- Ultra-soft, coated braid perfect for bottom-bait and pop-up rigs
- Could be mistaken for a normal, uncoated braid such is its softness
- Coating and inner braid features colour-break camouflage pattern
- Easy-to-strip outer coating
- Available in two colour options: Light Camo and Dark Camo
- Breaking strains: 15lb (6.8kg), 20lb (9kg), and 25lb (11.3kg)
- 20m on a spool



CORETEX™ TUNGSTEN

- Features unique tungsten-impregnated outer coating
- Soft, supple, sinking-braid inner
- Tungsten coating helps to pin hooklink to lakebed
- Coating is strippable for creation of combi rigs
- Two-tone colouring for camouflage
- Available in 20lb and 35lb breaking strains
- 20m per spool



CAMOTEX™ SEMI-STIFF

- Semi-stiff coating that sits in between the Camotex Stiff and Camotex Soft
- Perfect for bottom-bait and pop-up rigs
- Coating and inner braid both feature colour break camouflage pattern
- We recommend you remove outer coating before tying a knot in this material as it is so stiff the coating could break when knotting
- Steams very straight
- Has great anti-tangle properties
- Easy to strip outer coating
- Available in two colour options: Light Camo and Dark Camo
- Breaking strains: 15lb (6.8kg), 20lb (9kg), 25lb (11.3kg) and new 35lb (15.8kg)
- 20m on a spool



CAMOTEX™ STIFF

- Ultra-stiff coated braid that is perfect for bottom-bait and pop-up rigs
- Coating and inner braid both feature colour break camouflage pattern
- We recommend you remove outer coating before tying a knot in this material as it is so stiff the coating could break when knotting
- Has great anti-tangle properties
- Steams very straight making it great for stiff-rigs and boom sections on Hinged Stiff-rig
- Easy to strip outer coating
- Available in two colour options: Light Camo and Dark Camo
- Breaking strains: 15lb (6.8kg), 20lb(9kg), and 25lb (11.3kg)
- 20m on a spool



CAMO-SPLICE

- Spliceable braided hooklink
- Very supple and dense allowing it to pin to the lakebed
- Camouflage colour
- Ideal for creating multi-rigs and splicing hooks/swivels directly onto the hooklink, keeping them clear, neat and tidy without knots
- We recommend using the Easy-Splice Needle with this material
- Available in 50lb breaking strain
- 20m per spool



REFLEX™ CAMO

- Designed to be better than any other braided hooklinks currently available
- Features colour-break camouflage pattern
- Very supple braided hooklink material that is ideal for use in Rapide PVA bags
- Sinks without need for putty
- Available in two colour options – Light Camo and Dark Camo
- Breaking strains available are 15lb (6.8kg), 25lb (11.3kg) and 35lb (15.8kg)
- 20m per spool



RIGIDITY® TRANS KHAKI

- Improved version of the original Rigidity
- Features Trans Khaki camouflage for low visibility
- Stiffest Chod filament we have ever seen
- Perfect for Chod and Hinged Stiff-rigs
- Stiff nature makes it very hard for a carp to eject once it has been sucked in
- Whipping knot needs to be used with 30lb version
- Available in two breaking strains 25lb (11.3kg) and 30lb (13.6kg)
- Supplied on 30m spools!



ILLUSION® TRANS KHAKI SOFT HOOKLINK

- Improved Illusion hooklink that features our revolutionary Trans Khaki camouflage
- Perfect for gin-clear venues
- The most invisible hooklink Rob Hughes has ever dived over
- Fast sinking and supple
- High abrasion resistance and low stretch
- Great knot strength
- Perfect for a whole host of rig presentations
- Supplied on 50m spools
- Available in 12lb (5.45kg) and 15lb (6.8kg)



ZIG + FLOATER HOOKLINK

- Designed specifically for floater fishing and Zig Rig fishing
- Made from a copolymer mono, which gives it an incredibly low diameter so it is very unobtrusive in the water
- Incredibly strong with great abrasion resistance
- Quite possibly the number one choice for most of Europe's best surface and Zig Rig anglers
- Available in 9lb, 12lb and 15lb



ARMADILLO™

- Features colour-break camouflage pattern
- Designed to be used as a braided snag/shockleader
- Great for distance casting or when fishing snaggy venues
- Available in Light Camo or Dark Camo
- New 65lb version available for extreme snag fishing conditions
- Available in either 30lb (13.6kg), 45lb (20.4kg) or 65lb (29.5kg) breaking strains
- 20m per spool



ILLUSION® TRANS KHAKI FLUOROCARBON LEADER

- Features our revolutionary Trans Khaki camouflage
- Perfect leader material for gin clear venues
- Doubles up as effective hooklink material
- The most invisible fluorocarbon Rob Hughes has ever dived over
- Sinks like a brick and is incredibly supple meaning it hugs the contours of the lakebed giving the ultimate in concealed presentation
- High abrasion resistance and low stretch
- Great knot strength
- Supplied on 50m spools
- Available in 20lb (9kg) and 30lb (13.6kg)



CAMO LEADCORE

- Great for concealment and abrasion resistance
- Easy to splice, very supple, very dense and very strong
- Features colour-break camouflage pattern
- Available in two options in Light Camo and Dark Camo
- Available only in 45lb (20.4kg) breaking strain
- Supplied on both 7m and 25m spools

NEW



CAMO SUBMERGE®

- Lead-free leader material that features a unique "Fleck Camo" pattern to blend in perfectly over all lakebeds
- Incredibly subtle and sinks like a brick hugging the contours of the lakebed
- Easy to splice (use the yellow Edges needle for the 40lb and 50lb and the blue Edges needle for the 30lb - alternatively the Edges Easy Splice needle is perfect for all breaking strains)
- Available in 30lb, 40lb and 50lb
- 10m per spool

PVA STRIPS

- Designed for use with Chod/Heli Buffer Sleeve, Heli Buffer Sleeve and Angled Drop Off Run Rig Kit when wanting the lead to eject
- Small PVA strip threading into hole on sleeve and is cut down to size
- Melt time depends on water temperature
- 10 lengths supplied per packet

CPV047 PVA Strips



ANTI-TANGLE TUBING TRANS KHAKI

- Features revolutionary Trans Khaki camouflage
- Perfect for venues where leadcore is banned
- Added protection from abrasion and tangles
- Incredibly fish-friendly
- Supplied in 2m length

CAC564 Anti Tangle Tube 2m



LOADED TUNGSTEN RIG TUBE

- Four times heavier than leadcore
- Very supple so hugs the lakebed very well
- Perfect for venues where leadcore is banned
- Very easy to thread onto your mainline
- Supplied in 2m length

CAC535 Loaded Tungsten Rig Tube



LEADER SILICONE

- Designed for use on Submerge and leadcore leaders for helicopter rigs
- 0.5mm in diameter
- Features Trans Khaki camouflage
- Supplied in 1.5m length

CAC569 0.5mm x1.5m



DROP OFF HELI BUFFER BEADS

- Versatile buffer bead that comprises three main components and is designed for helicopter-style lead set-ups
- Designed to work on both leaders and naked mainline (simply add the tapered insert)
- Use without the tapered insert for lead-free/leadcore leaders
- Features Trans Khaki camouflage
- 6 x Buffer Beads and 6 x T-pegs per pack

CAC690 Drop Off Heli Buffer Beads



HELI BUFFER SLEEVE

- Designed for use with Helicopter Rigs on leaders such as Submerge and leadcore
- Small hole in the side allows you to set it up in a way for the lead to be ejected
- Features Trans Khaki camouflage
- 8 per packet

CAC584 Heli Buffer Sleeves x8



MICRO CHOD BEAD

- Designed to allow anglers to tie a 'fixed' Naked Chod Rig on fluoro or mono mainline
- The bead itself grips the line very strongly but can be moved the distance above the lead you require
- The bottom sleeve, sits over the lead and can be set up in way to eject the lead on a take
- When you hook a fish the bead slides down the line and slots into the top of the sleeve to protect your line during the fight
- Supplied with 6 sleeves and 6 beads per kit

CAC607 Micro Tungsten Chod Bead Kit x 6



DROP OFF INLINE LEAD KIT

- Designed for use with all Fox inline leads
- Allows inline lead to eject from line when fishing snaggy or weedy venues
- Comes supplied with a tail rubber if you want to increase the amount of pressure required to eject the lead
- 5 inserts and 5 tail rubbers per kit

CAC487 Drop Off Inline Lead Kit x 5 Insert



HELI/CHOD BUFFER SLEEVE

- Designed for Chod rigs and Helicopter rigs when fishing with fluorocarbon or mono mainline straight through
- The swivel of your rig will sit on the thin, tapered sleeve, which will absorb the pressure when playing a carp and prevent the swivel damaging the line
- Small hole in the side allows you to set it up in a way that allows the lead to be ejected
- Trans Khaki colour
- 6 per packet

CAC490 Chod/Heli Buffer Sleeves x 6



TUNGSTEN CHOD BEAD KIT

- Allows anglers to tie a 'fixed' Naked Chod Rig on fluoro or mono mainline
- The bead itself grips the line very strongly but can be moved the distance above the lead you require
- The bottom sleeve, sits over the lead and can be setup in way to eject the lead on a take
- When you hook a fish the bead slides down the line and slots into the top of the sleeve to protect your line during the fight
- Supplied with 6 sleeves and 6 beads per kit

CAC488 Tungsten Chod Bead Kit x 6

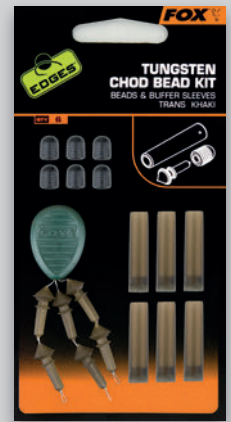

BIG BORE DROP OFF INLINE LEAD KIT

- Designed with a larger bore for use with leadcore and larger diameter lead-free materials such as 60lb Edges Submerge
- Compatible with all Fox inline leads
- Allows inline lead to eject from line when fishing snaggy or weedy venues
- Comes supplied with a tail rubber if you want to increase the amount of pressure required to eject the lead
- 5 inserts and 5 tail rubbers per kit

CAC698 Big Bore Drop Off Inline Lead Kit



DROP OFF LEAD PLUG & PINS

- Simply place the plug over your swivel and secure in place with T peg
- No longer need to cut inline lead insert in half when using Edges Drop Off Inline Lead Kit
- Means anglers can convert their drop off inline lead setup back to a standard inline lead set-up should they wish to
- Designed to work with all Fox inline leads
- 10 plugs and 10 pins supplied per packet
- Feature Trans Khaki camouflage

CAC635 Drop Off Lead Plus & Pins



SAFETY LEAD CLIP TAIL RUBBER

- Trans Khaki Colour
- Designed for use with size 7 Safety Lead Clip
- Small cut away section allows easier ejection of lead
- 10 per packet

CAC478 Safety Lead Clip Tail Rubber



SAFETY LEAD CLIP

- Trans Khaki colour
- Designed for use with a size 7 swivel
- 'Self-aligning' swivel design, which means the eye of the swivel always sits in line with the hole in the lead clip
- Fixes to swivel with T-peg (supplied)
- Serrations on the lug allows for adjustable tension
- 10 per packet

CAC477 Safety Lead Clip & Pegs Size 7



SLIK® LEAD CLIP TAIL RUBBER

- Trans Khaki Colour
- Designed for use with size 10 Slik Lead Clip
- Small cut away section allows easier ejection of lead
- 10 per packet

CAC478 Safety Lead Clip Tail Rubber



SLIK® SAFETY LEAD CLIP

- Trans Khaki colour
- Smaller lead clip designed to work with size 10 swivels making them perfect for delicate presentations
- 'Self-aligning' swivel design, which means the eye of the swivel always sits in line with the hole in the lead clip
- Fixes to swivel with T-peg (supplied)
- No serrations on the lug ensures that the tail rubber slips off easily
- Perfect for weedy and snaggy venues where ejecting the lead on a take is vital
- 10 per packet

CAC479 Slik® Lead Clips & Pegs Size 10



POWER GRIP LEAD CLIP KIT

- Handy kit that includes everything needed for creating a lead clip setup
- Includes following Edges Trans Khaki products: Power Grip Tail Rubbers, size 7 Lead Clips with T pegs, standard Anti Tangle Sleeves
- Also supplied with both standard size 7 swivels and size 7 Kwik Change Swivels.
- Five of every component supplied in kit

CAC638 Power Grip Lead Clip Kit



POWER GRIP NAKED LINE TAIL RUBBER

- Tougher grip on lead clip for use with heavier leads
- Fine taper at rear of tail rubber for use with fluorocarbon leaders or fishing mainline straight through
- Helps to prevent hooklinks from tangling around the tail rubber
- Ideal for long rigs such as Zig Rigs
- Trans Khaki camouflage
- Designed for use with size 7 lead clips
- 10 per packet

CAC686 Power Grip Naked Line Tail Rubbers



NAKED LINE TAIL RUBBERS

- Fine taper at rear of tail rubber for use with fluorocarbon leaders or fishing 'naked' mainline straight through
- Helps to prevent hooklinks from tangling around the tail rubber
- Ideal for long rigs such as Zig Rigs
- Front of tail rubber features cut away section to aid lead ejection
- Trans Khaki camouflage
- 10 per packet

CAC636 Naked Line Tail Rubbers



POWER GRIP TAIL RUBBERS

- Designed for anglers that like to use heavy leads ensuring lead doesn't eject on impact with water after a cast but still ejects when comes into contact with snag/weed
- Designed to work with a size 7 Edges Lead Clip
- Trans Khaki camouflage
- 10 per packet

CAC637 Power Grip Tail Rubbers



TADPOLE MULTI BEAD

- Trans Khaki colour
- Perfect for creating semi-fixed running set-up with inline leads
- 10 per packet

CAC476 Tadpole Multi Bead



RUNNING SAFETY CLIP

- Features Trans Khaki camouflage
- Designed to allow you to create the perfect running rig presentation
- T-bar peg to lock the swivel in place inside main clip
- The clip is sculpted to allow the lead to hang straight for increased casting distance
- Tail rubber is designed to be used with both leadcore style leaders and tubing
- Kit includes a Run Ring and Speed Link so you can attach your lead of choice

CAC582 Running Safety Clips



ANGLED DROP OFF RUN RIG KIT

- Unique design that takes running rigs to another level
- Angled, large ring sits in perfect place to allow line to run through unhindered
- Can be set up to eject the lead when fishing weedy or snaggy venues
- Trans Khaki Camouflage
- Comprises 6 x Angled Clips, 6 x Angled Buffer Sleeves and 6 x T-Pegs

CAC600 Angled Drop Off Run Rig Kit x 6



TUNGSTEN ANTI TANGLE

- Designed to help prevent tangles occurring on the cast
- Added weight of tungsten helps to keep your hooklink pinned to the lakebed
- Available in standard and Micro sizes
- 8 sleeves per packet

CAC630 Tungsten Anti Tangle Sleeve Micro

CAC631 Tungsten Anti Tangle Sleeve Standard



RUN RING KIT

- Simple design to create a basic running rig
- Large ring for friction free movement
- Allows great bite indication
- Features 8 x Rings, 8 x Buffer Beads and 8 x Speed Links
- Features Trans Khaki camouflage

CAC583 Running Ring Kit



TULIP BEADS

- Perfect for use with running rigs
- Angled to allow lead to sit at optimum angle for tangle-free casts
- Can also be used as a buffer bead on marker float set up
- Trans Khaki camouflage

CAC599 Tulip Beads

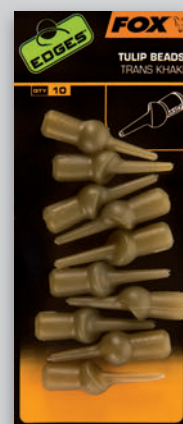

TRANS KHAKI ANTI TANGLE SLEEVES

- Designed to help prevent rigs from tangling on cast
- Standard ideal for normal everyday rig presentations
- Micro sleeve available for solid PVA bag fishing
- XL sleeve ideal for use with long hooklinks such as Zig Rigs
- 25 per packet (Micro and standard); 15 per packet (XL)

CAC481 Anti Tangle Sleeves x 25

CAC555 Anti Tangle Sleeves Micro x 25

CAC554 Anti Tangle Sleeves X Large x 15

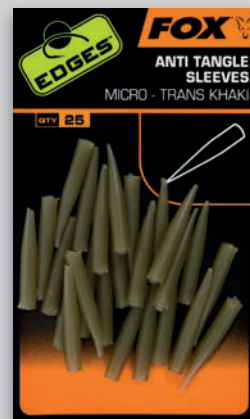

TUNGSTEN POWERGRIP® PUTTY

- Extremely dense
- Very easy to work with
- Perfect for counterbalancing pop-ups and pinning rigs to lakebed
- Widely regarded as best on the market

CAC541 Powergrip Putty



TUNGSTEN LINE GUARD BEADS

- Designed for use directly onto naked mainline
- Can be fixed up the line for use with Naked Chod Rigs (will slide down and sit on top of Heli Buffer Sleeve once a fish is hooked)
- Can also be positioned directly on top of a Heli Buffer Sleeve when fishing naked helicopter-style rigs
- Handy tapered side that your hooklink swivel sits on during the fight to keep mainline protected
- Tungsten content helps to sink them to lakebed
- Supplied on wire loop for easy loading to mainline
- 8 beads per packet

CAC671 Tungsten Line Guard Bead x8



TUNGSTEN HOOKLINK SINKERS

- Designed to mimic look for tungsten putty on hooklink
- Ideal for helping to pin your hooklink to lakebed
- Supplied on wire loop, 9 per packet

CAC585 Tungsten Hooklink Sinkers



TAPERED BORE BEADS

- Available in 6mm and 4mm
- Feature Trans Khaki camouflage
- 4mm designed to grip leadcore when using Helicopter and Chod rigs
- 6mm beads perfect for acting as a buffer to protect knots
- 6mm beads can also be placed on silicone on a leader when using Chod and Helicopter rigs
- 30 beads per packet

CAC557 4mm Bore Beads x 30

CAC558 6mm Bore Beads x 30

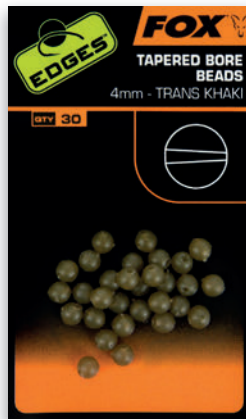

BAIT FLOSS

- Designed for attaching hookbaits to rig rings and Mini Hook Ring Swivels
- Neutral colour
- Supplied in dispenser with built-in cutter
- 50m per spool

CAC512 Bait Floss 50m



TAPERED MAINLINE STOP

- Large tapered stop for use on mainline, which you can then place a 5mm Tungsten Bead onto when fishing Chod or Helicopter rigs 'naked' style
- Taper allows hooklink swivel to dislodge bead easier making it safer than conventional designs
- Supplied on wire loop, 9 per packet

CAC492 Tapered Mainline Stoppers x 9



5MM TUNGSTEN BEAD

- 5mm bead made from tungsten
- Designed to fit neatly onto the Tapered Mainline Stop
- 15 beads per packet

CAC489 Tungsten Bead 5mm x 15



BAIT BUNGS

- Designed to prevent a hookbait sliding down the Hair towards the hook
- Especially useful when using 'snowman' presentation to keep two baits next to each other on the Hair
- Simply slide onto the hooklink before tying the loop on the Hair
- Supplied on wire loops
- 10 Bungs per packet

CAC687 Bait Bungs



MARKER ELASTIC

- Red elastic supplied on a 20m spool
- Perfect for marking fishing lines to ensure accurate casting and bait placement
- Very easy to work with, grips the line without damaging it
- Easy to remove from line again without damaging it

CAC484 Marker Elastic 20m Red



ANTI BORE BAIT INSERTS

- Unique design that is pushed into base of hookbait to prevent Hair erosion
- Ideal for boilies and soft hookbaits such as meat
- Comes into its own when repeatedly casting out and reeling in
- Micro-serrations on tube ensure rock solid fit
- Can be cut down to fit smaller baits

CAC539 Anti Bore Bait Insert



HOOK SILICONE

- Designed for trapping Hair on shank of hook for blow back rigs
- Features Trans Khaki Camouflage
- Supplied in 1.5m lengths
- Two sizes available for different hook sizes – 10-7 and 6-2

CAC567 Hook Silicone 10 - 7

CAC568 Hook Silicone 6 - 2



WITHY CURVES

- Pre-curved adaptor set at perfect angle for Withy Pool Rig
- Threads onto hooklink via splicing needle
- Features Trans Khaki camouflage
- Micro serrations on the end of the sleeve for tungsten putty to mould around to counter balance your pop-up hookbait
- No longer need to shrink tubing down over a kettle to create this all-time classic rig!
- 10 per packet

CAC561 Hook Size 10-7

CAC562 Hook Size 6-2



MICRO LINE ALIGNAS

- More refined version of the hugely popular Trans Khaki Line Alignas
- Ideal for anglers that wish to fish scaled-down, delicate presentations
- Eliminates need for shrink tube
- Helps to create perfect aggressive hooking angle
- Available in two sizes: 10-7 and 6-2
- 10 per packet

CAC633 Micro Line Aligna 10-7

CAC634 Micro Line Aligna 6-2

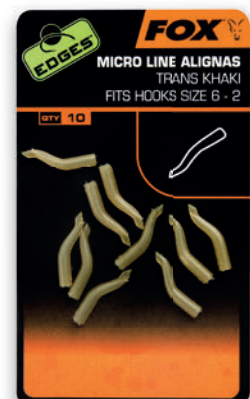

SILICONE SLEEVES

- 3mm bore in 25mm lengths
- Features Trans Khaki camouflage
- Perfect for numerous rig applications such as placing over Speed Links
- 15 lengths per packet

CAC571 Silicone Sleeves



SHRINK TUBE

- Perfect for extending shank of hook when making anti-eject rigs
- Trans Khaki colour
- Available in three sizes: X Small (1.4-0.6mm), Small (1.8-0.7mm) and Medium (2.4-0.8mm)

CAC474 X Small - 1.4 - 0.6

CAC475 Small - 1.8 - 0.7

CAC570 Medium - 2.4 - 0.8



LINE ALIGNA

- Makes creating a line-aligner presentation easier than ever before
- Features Trans Khaki camouflage
- Simply slide an Aligna down your hooklink and over the eye of your hook
- Creates an aggressive hooking angle that carp find very hard to eject
- Two sizes available for different hook sizes – 10-7 and 6-2
- 10 per packet

CAC560 Hook Size 6-2

CAC559 Hook Size 10-7

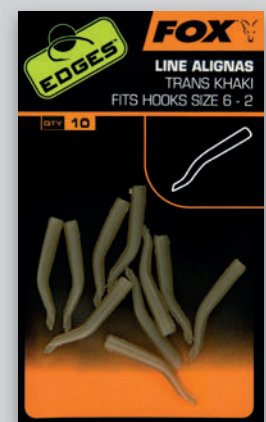

HAIR WIDGETS

- Design to tightly grip shank of hook
- Enables Hair Rig to be created without tying knotless knot
- Simply tie a supple hair to the Hair Widget and position it in chosen place on hook
- Features Trans Khaki camouflage
- 30 per packet

CAC556 Hair Widgets x 30



HOOK BEADS

- Trans Khaki Colour, 25 beads per packet
- Ideal for blowback presentation where a knotless knot isn't used
- Grip the shank of the hook very tightly
- Available in two sizes: 7-10 and 2-6

- CAC482 Hook Bead - Size 7-10
- CAC483 Hook Bead - Size 2-6

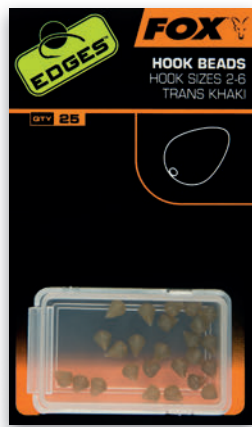

KURO RIG RINGS

- Perfect for a host of rig applications including creating Blowback Rigs
- Feature matt black Kuro coating
- Available in three sizes: Small (2.5mm), Medium (3.2mm) and Large (3.7mm)
- 25 rings per packet

- CAC543 Kuro Rig Rings 2.5mm
- CAC544 Kuro Rig Rings 3.2mm
- CAC545 Kuro Rig Rings 3.7mm

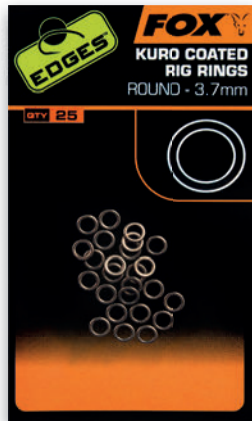

MICRO SPEED LINKS

- Scaled down version of original Speed Link
- Designed to allow quick changing of rigs
- Can also be used for quick changing of items such as marker floats and spods
- 20 per packet

- CAC566 Micro Speed Links

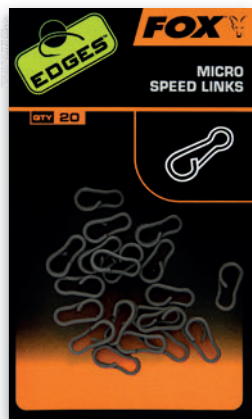

MAGGOT CLIPS

- Designed for easy presentation of maggots on Hair Rigs
- Unique arrowhead shape to prevent maggots bunching up
- Feature chemically sharpened points with non-rust finish
- Available in four sizes: 6, 8, 10 and 12
- 10 clips per packet

- CAC524 Maggot Clips Size 6
- CAC525 Maggot Clips Size 8
- CAC526 Maggot Clips Size 10
- CAC527 Maggot Clips Size 12



HEAVY DUTY 'O' RING

- Designed for use when setting up helicopter and Chod rigs to eject the lead on the take
- Anti-glare finish
- 15 per packet

- CAC496 Heavy Duty 'O' Ring x 15



SPEED LINKS

- Designed to allow quick changing of rigs
- Can also be used for quick changing of items such as marker floats and spods
- Available in two sizes: standard and Micro
- 20 Speed Links per packet

- CAC532 Speed Links x 20

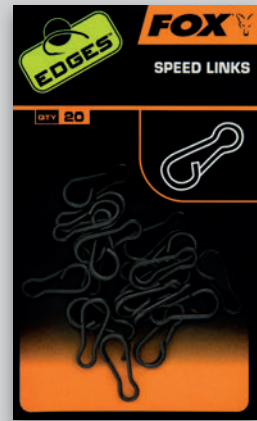

RIG LINKS

- Designed to replace loop knots on end of rig
- Simply tie Rig Link to end of rig with a Grinner Knot
- Allows rigs to be changed in double-quick time
- Enables PVA sticks to be threaded down hooklink
- 15 per packet

- CAC542 Rig Links x 15

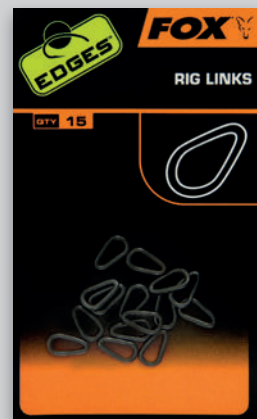

HAIR BRAID

- Designed to allow anglers to create super-supple Hair Rigs
- Discreet brown colour
- Perfect when using small, lightweight hookbaits
- Supplied in 10m lengths

- CAC565 Hair Braid 10m



MICRO RIG SWIVELS

- Perfect for mounting hookbaits onto when using D-Rig presentations
- Ideal for Chod and Hinged Stiff-rigs
- 20 per packet

CAC538 Micro Rig Swivels x 20

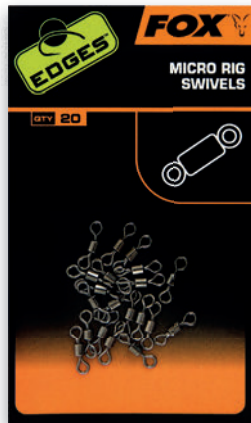

SWIVELS

- Perfect for a host of rig applications
- Anti-glare finish
- Available in two sizes: 7 and 10
- 20 swivels per packet
- Perfect for use with Edges Safety (size 7) and Slik (size 10) lead clips

CAC533 Swivels Size 7 x 20

CAC534 Swivels Size 10 x 20

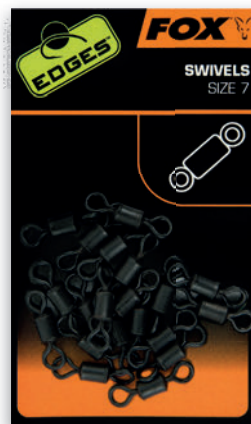

DOUBLE RING SWIVEL

- Perfect for anglers that fish inline drop off set-up but want to tie rig straight to swivel
- Size 7 swivel with anti glare finish
- 8 per packet

CAC495 Double Ring Swivel Size 7 x 8

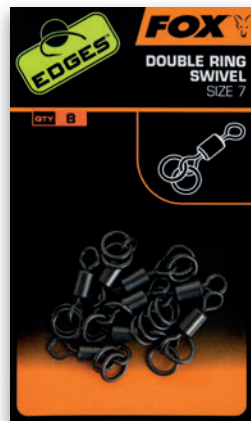

KURO MICROHOOK RING SWIVELS

- Perfect for mounting hookbaits onto when using D-Rig presentations
- Gives hookbaits greater flexibility and 360° movement
- Matt black Kuro coating
- Ideal for a host of rigs including 360, Chod, Hinged Stiff and Multi Rig
- 10 per packet

CAC586 Kuro Micro Hook Ring Swivel x 10



KWIK CHANGE SWIVELS

- Available in size 7 and 10
- Allows rigs to be changed without cutting and retying knots
- Anti-glare finish
- Perfect for use with Edges Safety and Slik lead clips
- 10 per packet

CAC485 Kwik Change Swivels Size 7 x 10

CAC486 Kwik Change Swivels Size 10 x 10



KWIK CHANGE DROP OFF INLINE SWIVEL

- Unique design for anglers who want to fish inline drop off but still have quick range facility with their rigs
- Size 7 swivel with anti glare finish
- 8 per packet

CAC494 Kwik Change Swivel Size 7

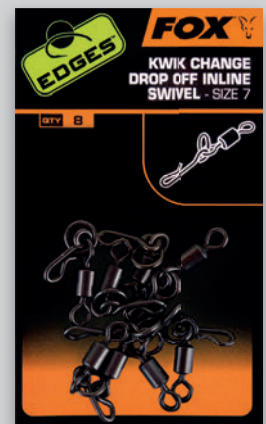

KWIK CHANGE 'O' RING

- Another design that is unique to the Edges range
- Designed for anglers that fish helicopter rigs but want to change hooklinks without cutting and tying knots
- Anti-glare finish
- 10 per packet

CAC493 Kwik Change 'O' Ring x10



FLEXI RING SWIVELS

- Available in size 7, 10 and 11
- Anti-glare finish
- 10 per packet

CAC528 Flexi Ring Swivels Size 7

CAC609 Flexi Ring Swivels Size 10

CAC529 Flexi Ring Swivels Size 11

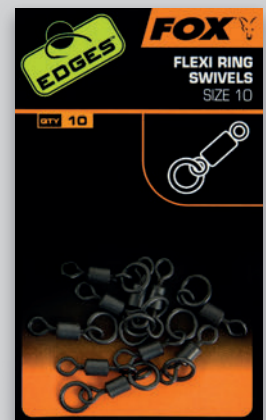

BOILIE STOPS

- Feature tapered ends for easy placing into Hair loop
- Small and discreet on top of boilie
- Clear colour
- Available in two size: Micro and Standard
- 200 boilie stops per packet

- CAC592 Boilie Stops Micro
CAC593 Boilie Stops Standard

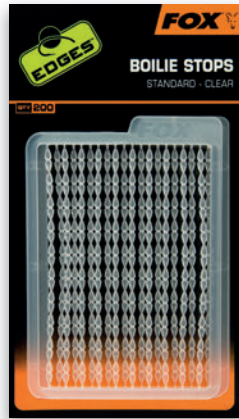

PELLET PEGS

- Designed for securing pellets in place on Hair Rigs
- Low-vis clear colour
- Available in three sizes: 11mm (180 pegs), 13mm (134 pegs) and 21mm (50 pegs)

- CAC519 11mm Pellet Pegs x 180
CAC520 13mm Pellet Pegs x 134
CAC521 21mm Pellet Pegs x 50



MULTI PURPOSE BACKLEAD

- Can be used as a quick-change flying backlead or converted into a traditional 'clip on' backlead.
- To change, simply remove the quick-change flying insert from the lead and replace with the 'clip-on' backlead insert by pushing it into the core, twist the insert once in place to ensure lead cannot come off
- If the 'clip-on' backlead should become snagged, it is designed to release from the line as the clip will spring open, releasing your line
- When used in flying backlead mode it has been designed not to fly too far back up the line like other makes currently do, this helps to ensure that the line closest to your rig will be pinned down
- Perfect for pinning your line to the lakebed when fishing for line-shy carp, also ideal when fishing on venues with boat traffic to keep the line out of harm's way
- Available in 3 sizes – 5g, 10g and 15g
- Each pack contains 4 x leads, 4 x flying backlead inserts and 4 x 'clip-on' backlead inserts

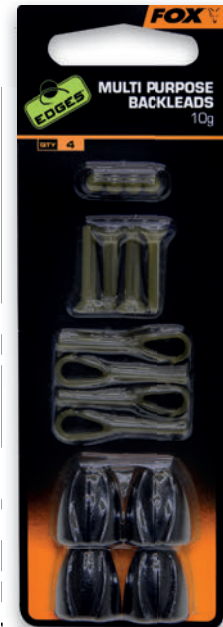

- CAC653 Multi Purpose Backlead 5g
CAC654 Multi Purpose Backlead 10g
CAC655 Multi Purpose Backlead 15g

BOILIE CAPS

- Mini hook on base that pulls up into hookbait
- Makes it very hard for nuisance species to dislodge bait from Hair
- Small, clear cap almost disappears on top of bait
- 120 Boilie Caps per packet

- CAC601 Boilie Caps



DOWN RIGGER BACKLEADS

- Unique backlead system that can be attached to mainline with one hand
- Available in two sizes: 21g and 43g
- Three backleads per packet

- CAC312 Down Rigger Back Leads 21g x 3
CAC313 Down Rigger Back Leads 43g x 3



CAPTIVE BACK LEADS MK2

- Perfect for angler who wishes to keep their line concealed
- Patented line clip allows for smooth line release
- Heavier options allow you to fish with tighter lines for better indication
- Supplied on own winder
- Comes supplied with 10m highly-visual orange cord
- Cord freely dispenses from winder



- CBW001 Captive Back Leads MK2 1.25oz / 35g
CBW002 Captive Back Leads MK2 2oz / 56g
CBW003 Captive Back Leads MK2 3oz / 85g
CBW004 Captive Back Leads MK2 4oz / 113g
CBW005 Captive Back Leads MK2 5oz / 142g



NEEDLE SET

- Five-piece needle set that features everything you need
- Comprises Stix & Stringer, Fine, Heavy, Gated and Splicing needles

CAC598 Needle Set



STIX & STRINGER NEEDLE

- Extra-long gate latch needle
- Ideal for creating PVA stringers
- Also suited to threading PVA sticks onto hooklinks

CAC523 Stix & Stringer Needle



FINE NEEDLE

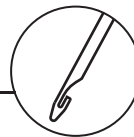

- Perfect for delicate hookbaits such as particles
- Also suited to soft, small 6-10mm boilies
- Soft-touch easy-grip, green handle

GATED NEEDLE

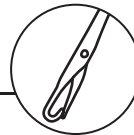

- Gate latch baiting needle for use with variety of hookbaits
- Also helpful for threading small PVA bags onto hooklink
- Soft-touch easy-grip, yellow handle

EASY SPLICE NEEDLE

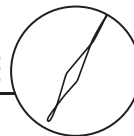

- Twisted stainless steel wire designed for splicing leadcore and lead-free leader materials as well as splicing Edges Camo-Splice hooklink material
- Diamond shaped for ease of use

SPLICING NEEDLE

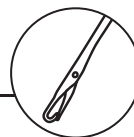

- Fine gate latch needle for splicing leadcore and lead-free materials
- Can also be used as a baiting needle for small, soft, delicate hookbaits
- Soft-touch easy-grip, blue handle

HEAVY NEEDLE

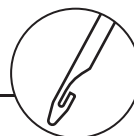

- Perfect for tougher hookbaits such as boilies and nuts
- Soft-touch easy-grip, red handle

CAC588 Fine Needle

CAC522 Splicing Needle

CAC590 Gated Needle

CAC589 Heavy Needle

CAC699 Easy Splice Needle



KWIK CHANGE POP-UP WEIGHTS

- Pop-up counter weight system
- Easy to attach to hooklinks without causing any damage
- Weights simply attach to small silicone length that is supplied on dispensers
- Available as individual weights: BB, AAA, SA and Swan
- Six division dispenser also available featuring No.1, No.4, BB, AAA, SA and Swan

CAC513 Pop-Up Weights BB

CAC514 Pop-Up Weights AAA

CAC515 Pop-Up Weights SA

CAC516 Pop-Up Weights Swan

CAC518 Weights Dispenser



MULTI TOOL

- Handy device that features four tools in one!
- One end is a line stripper for removing outer coating from coated braids
- Tension hook on opposite end to stripper, which is used for tightening knots and straightening stiff materials
- Also features small D-Rig spike for opening out and creating a neat D shape

CAC587 Multi Tool



BRAID BLADES

- Super-sharp blades for effortless cutting of braided materials
- Also great for cutting materials like fluorocarbon, nylon and leader materials
- Hi-vis orange handle to prevent you losing them in the grass etc

CAC563 Braid Blades



TENSION BAR

- Handy tool for tightening loops
- Also useful when straightening out boom sections on stiff-rigs
- Ergonomic grip

CAC510 Tension Bar

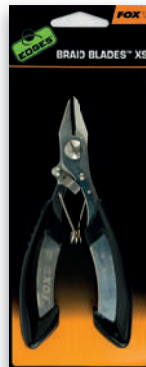

BRAID BLADES XS

- Saw-toothed blades designed to cut easily through all manner of materials including braid, nylon, stiff mono, fluorocarbon, leadcore and coated braid
- Razor-sharp
- Handy locking clip to keep them closed when not in use
- Fits neatly into your F Box tackle box

CAC563 Braid Blades



1MM MICRO DRILL

- Designed for drilling ultra-fine holes into hookbaits
- Allows you create a bore in a hard bait for your baiting needle
- Perfect for hard baits such as nuts, air-dried boilies and corkball pop-ups
- Ergonomically designed highly visual handle

CAC632 1mm Micro Drill

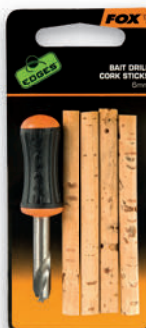

BAIT DRILL & CORK STICKS

- Small drill that is used to bore out hookbaits
- Ideal for baits such as boilies and tiger nuts
- Ergonomic handle on drill for easy use
- Supplied with 5 cork sticks (6mm) for inserting into baits to give them increased buoyancy
- 6mm Cork Sticks also available to purchase separately

CAC591 1.5mm Nut/Pellet Drill





CAMOTEX™ FLAT PEAR SWIVEL

- Low profile
- Large eye swivel
- Camouflage, anti-glare finish
- Perfect for short/medium range



CAMOTEX™ INLINE FLAT PEAR

- Features groove on outside for use with inline drop-off rigs
- Low profile
- Solid plastic insert
- Camouflage, anti-glare finish
- Perfect for short-medium range, or long range when fished inside solid PVA bag
- Inline leads feature hard, plastic inserts for use with size 7 swivels



CAMOTEX™ IMPACT INLINE

- Rig exits the lead from the centre to ensure the fish comes into contact with the full weight of the lead upon straightening the hooklink
- Unique design helps to set the hook and convert more pick-ups
- Perfect for short-medium range plus solid PVA bag fishing
- Features Camotex camouflage coating
- Available in three sizes – 3oz/85g, 4oz/113g and 5oz/142g
- Can also be fished inline drop off style in conjunction with Edges Drop Off Inline Kit



CAMOTEX™ SQUARE SWIVEL

- Perfect for fishing on slopes
- Offer great resistance when fish picks up rig
- Large eye swivel
- Camouflage, anti-glare finish
- Perfect for short-medium range



CAMOTEX™ SQUARE INLINE

- Features groove on outside for use with inline drop off rigs
- Offers great resistance when fish picks up rig
- Solid plastic insert
- Camouflage, anti-glare finish
- Perfect for short-medium range or long range when fished inside solid PVA bag



CAMOTEX™ DISTANCE SWIVEL

- Perfect for casting long distances
- Aerodynamic profile
- Large eye swivel
- Camouflage, anti-glare finish

FEATURES

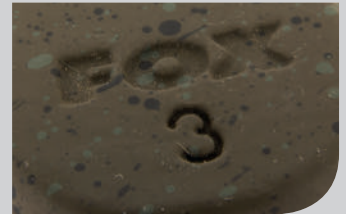

Weight imprinted on the lead itself



All swivels also feature camouflage coating



Hardwearing, anti-glare camouflage coating



Inline leads feature hard, plastic inserts for use with size 7 swivels



FLAT PEAR

- Dumpy, condensed shape
- Perfect for slopes and sides of bars
- Shapes offers great bolt effect
- Swivel and inline
- Brown and Green



TRI-BOMB

- Perfect all-rounder
- Weight forward design increases resistance
- Stable in flight
- Swivel and inline
- Brown and Green



PASTE BOMB

- Perfect for use with paste or Method mixes
- Increases attraction around hookbait
- Better hooking potential than traditional feeder
- Swivel and inline
- Brown and Green



KLING ON

- Unique to Fox
- Flat profile and pronounced studs give unrivalled grip on slopes
- Perfect for running water and long range boat fishing
- Swivel and inline
- Brown and Green



EXOCET®

- Weight forward design for long-range casting
- Very stable in flight
- Distances in excess of 200m achieved
- Swivel
- Brown and Green



ELEVATOR™

- Unique shape ideal for flowing water
- Three sided profile enable lead to lift off lakebed instantly and hit surface much quicker
- Swivel
- Brown and Green



HORIZON®

- Hexagonal shape makes lead perfect for distance casting
- Very stable in flight
- Flat sides help lead to hold bottom
- Swivel and inline
- Brown and Green

FEATURES

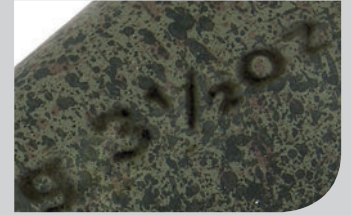

Weight imprinted on the lead itself



All swivel leads feature rubber coated swivels with large eyes



Rubberised coating gives non-reflective and durable camouflage coating

ZIG ALIGNA™ KIT

- 3 lengths of Zig Aligna HD Foam
- 6 Zig Aligna Sleeves
- 1 x Loading Tool



CAC467 Zig Aligna Kit (Black, Red, Yellow)

ZIG ALIGNA™ LOADING TOOLS

- Designed for loading foam into loop on back of Zig Aligna
- Hi-vis orange colour
- Two per packet



CAC506 Zig Aligna Loaded Tools x 2 Orange

ZIG ALIGNA™ HD FOAM

- Available in Red, Yellow and Black
- 3 lengths of foam per packet
- Ultra-buoyant



CAC471 Zig Aligna Foam x3 Red
CAC472 Zig Aligna Foam x3 Yellow
CAC473 Zig Aligna Foam x3 Black

ZIG ALIGNA™ SLEEVES

- Available in Red, Yellow, Fluoro Pink and Fluoro Orange
- 8 Zig Aligna Sleeves per packet



CAC468 Zig Aligna Sleeves x8 Red
CAC469 Zig Aligna Sleeves x8 Yellow
CAC665 Zig Aligna Sleeves x8 Fluoro Orange
CAC667 Zig Aligna Sleeves x8 Fluoro Pink

HALO® ZIG FLOAT KIT

- Perfect for deep lakes where conventional Zig Rigs are impractical
- Designed for use with leads of 3oz (85g) or heavier
- Ultra buoyant high impact plastic
- Supplied with interchangeable nose caps in red and black
- Kit includes float and lead boom with large-eye ring swivel, buoyancy bead and lead link attachment



CAC375 Halo Zig Float Kit *RRP £16.99



MINI HALO® ZIG FLOAT KIT

- Scaled down version of the standard Halo Zig Float Kit
- Ideal for smaller venues
- Interchangeable high visibility red and black nose cones
- Perfect for deep lakes where conventional Zig Rigs are impractical
- Ultra buoyant high impact plastic
- Kit includes float and lead boom with large-eye ring swivel, buoyancy bead and lead link attachment
- Works with leads as light as 2oz

CAC428 Mini Halo Zig Float Kit *RRP £14.99

ZIG ALIGNA™ BENEFITS

- ✓ **Better hookholds and anti-eject properties** - Creates a much wider gape than a standard knotless knot or Zig Bug-style hook (no fluff or foam impeding hook point penetration), for much better hooking potential.
- ✓ **Better hooking potential** - The Aligna allows your hookbait to sit centralised at all times - a downside with a knotless knot on light mono is that the Hair naturally wants to sit off to one side, which can lead to poor hook holds.
- ✓ **Stronger more reliable knots can be used** - Allows you to attach your hook to your hooklink with a Palomar or Grinner Knot rather than a Knotless Knot, which are much stronger and also prevents the eye of your hook from rubbing on and weakening the hooklink when playing a fish.
- ✓ **Far greater value for money** - Should your hook-point turn over you can simply slide the Aligna up your hooklink and attach a new hook - with Zig Bug-style hookbaits once the point has gone they have to be thrown away, which can get very expensive.
- ✓ **Very versatile** - You can mix and match the colours of foam and Zig Aligna to create a whole host of hookbait colour options until you find the combo that works the best on any given day.
- ✓ **Very quick and easy** - Changing of your hookbait is very quick to do, and swapping hookbaits is also very fast thanks to the unique loading tool
- ✓ **Imitate shape of emerging larvae** - Most Zig Bug style hookbaits imitate creatures that live out of the water, which is a pretty pointless imitation as they are not natural! The shape of the Zig Aligna combined with a foam insert very much replicates the shape of a nymph with a thin curved body and a big head.
- ✓ **Hi-Vis colour options** - The red, pink, white and yellow options allow you to create hi-vis hookbaits when single hookbait fishing or spodding a slop over the top.





MICRO MARKER FLOATS

- Perfect for feature finding and depth reading
- Ideal for short-medium range with leads up to 3oz (85g)
- Each pack contains three colours: yellow, black and orange
- Full kit option also available

		*RRP
CAC381	Micro Marker x3	£8.99
CAC382	Micro Marker Float Kit x3	£17.99



EXOCET® & DART MARKER FLOATS

- Perfect for feature finding and depth reading
- Constructed from high impact materials to make them robust and reliable
- Both available as float alone or as part of a kit, which includes 3 x flights, large eye ring swivel, anti-tangle boom and buoyancy aid
- Air cavity for extra buoyancy

		*RRP
CAC353	Exocet Marker Float	£9.99
CAC354	Exocet Marker Float Kit 3oz	£17.99
CAC355	Exocet Marker Float Kit 4oz	£18.99
CAC368	Dart Marker Float	£7.99
CAC369	Dart Marker Float Kit 2oz	£16.99
CAC370	Dart Marker Float Kit 3oz	£17.99

BOLT BUBBLE FLOATS

- First ever bubble-style float designed for surface feeding carp
- Streamlined, weight-forward design aids casting distance and also increases resistance when a fish straightens hooklink
- Anti-spook transparent body and low profile
- Casting weight adjusted by filling float with water
- Designed to be used in-line
- Supplied with two anti-tangle sleeves
- Available in four sizes: Small, Medium, Large and X-Large



		*RRP
CAC160	Bolt Bubble - Small	£8.99
CAC161	Bolt Bubble - Medium	£8.99
CAC162	Bolt Bubble - Large	£8.99
CAC163	Bolt Bubble - XL	£8.99

EXOCET® CONTROLLER FLOATS

- Aerodynamic design ensures not only long distances can be achieved but, accuracy too
- Hooklink exits the float at an angle on the cast, almost like a helicopter rig, which helps to reduce chance of tangles
- Stubby shape designed to reduce diving on impact with water
- Features flat faces to increase the bolt effect when a carp straightens the hooklink, which helps to improve hooking
- Flat sides also enable you to 'mend' your mainline on the surface without moving the float too much
- Removable body allows easy changing of controller sizes and also means you don't have the body banging against the rod blank when travelling to and from a venue
- Hi-viz cap easy to see at range
- Low-Viz semi-transparent body looks inconspicuous in water
- Supplied with Standard swivel and Kwik Change Swivel plus a Micro Anti Tangle Sleeve to go over either swivel
- Two sizes available – Medium and Large



		*RRP
CAC614	Exocet Medium Controller Float	£5.99
CAC615	Exocet Large Controller Float	£5.99



H-MARKER

- Designed for marking spots when boat fishing
- Bright orange for maximum visibility
- Ultra-buoyant
- Betalight slots
- Supplied with heavy lead weight to anchor to the lake/river bed
- Supplied with 20m (65ft) cord

		*RRP
CAC424	H-block Marker	£9.99



MINI H-BLOCK MARKER

- Handy mini version of our H-Marker for anglers that wish to angle with a little more stealth or use a bait boat
- Bright orange for maximum visibility
- Ultra buoyant
- Betalight slots
- Supplied with Swivel & Speed Link for easy lead attachment
- Supplied with 10m (32ft) cord
- Two per packet

		*RRP
CAC426	Mini H-blocks x 2 red	£8.49



IMPACT SPOD

- Designed for fast and effective baiting up with a host of different baits
- Boasts a number of unique features
- 'Scoop' body shape allows for rapid, single-handed loading
- Body and lid design allows for efficient loading as one scoop will fill the entire inner compartment
- Designed to have perfect weight distribution to aid casting distance and accuracy
- Scoop design enables tapered bait release for creating a wider spread of free offerings
- Designed to float so in the event of a 'crack off' it can be retrieved
- Robust hinge design that isn't impeded by bait
- Spring mechanism on nose is full encapsulated to prevent bait interference
- Heavy duty swivel that is moulded into flight

		*RRP
CAC639	Impact Spod Medium	£11.99
CAC640	Impact Spod Large	£13.99

FEATURES

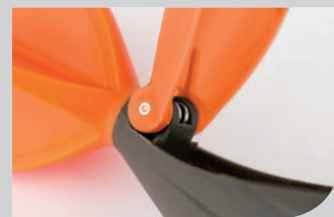

Robust hinge that cannot be impeded by bait



Spring mechanism on nose is encapsulated to prevent bait interference

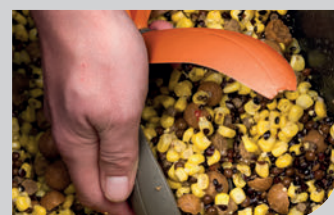

The Impact Spod is sold under licence from Spomb Fishing Limited. SPOMB® is a Registered Trade Mark of Spomb Fishing Limited

GRAPPLING MARKER LEADS

- Unique design to aid your feature finding
- Features four prongs that will pick up traces of lakebed debris, weed and natural food items to enable you to establish exactly what you are fishing over
- Weight-forward design enables them to be cast a long way
- Dumpy nose ensures more of the lead is in contact with the lakebed so more vibrations are transmitted up the braided line to the marker rod tip
- Once you have identified a likely-looking spot with a normal lead simply swap to this design for a more thorough investigation
- Two leads per pack
- Available in three sizes – 3oz/85g, 4oz/113g and 5oz/142g



		*RRP
CLD229	Grappling Marker Lead 3oz (85g) x 2	£6.49
CLD230	Grappling Marker Lead 4oz (113g) x 2	£6.79
CLD231	Grappling Marker Lead 5oz (142g) x 2	£6.99

MARKER STICKS

- 24ins (60cm) long sticks for measuring distance to enable accurate casting
- Hi-vis, tapered orange tops with betalight slot in top
- Lightweight aluminium construction
- Two sticks supplied per pack



		*RRP
CAC616	Marker Sticks 24" x 2	£10.99

Rangemaster



RANGEMASTER® PLASTIC THROWING STICKS

- Designed for baiting up with boilies at mid-long range
- Constructed from lightweight, flexible plastic that is very robust
- CAD designed shape for maximum distance
- Non-slip rubber handle
- Available in 20mm and 26mm options

		*RRP
CAC672	Rangemaster 20 Throwing Stick	£16.99
CAC673	Rangemaster 26 Throwing Stick	£16.99



RANGEMASTER® R20 CARBON THROWING STICK

- Lightweight carbon construction
- Handy loading port above handle for effortless loading and faster more accurate baiting
- Reduces arm ache associated with metal and plastic sticks when mass baiting
- Handle is oval-shaped to prevent twisting in the hand, which in turn aids accuracy

- Distances over 150m achieved in right hands
- For use with baits up to 20mm
- Supplied in protective case

		*RRP
CAC608	Carbon R20 Throwing Stick inc. case	£84.99

Rangemaster® R20 Carbon Throwing Stick supplied in protective case



CAMO SQUARE BUCKETS

- Available in 5 litre, 10 litre and 17 litre
- Perfect for spod mixes, maggots and groundbaits
- Square design makes them much more barrow-friendly than a more conventional round bucket
- Easier to stack and also easier to store in your car
- Extra strong metal handle

		*RRP
CBT005	Camo Square Bucket 5L	£5.99
CBT006	Camo Square Bucket 10L	£7.99
CBT007	Camo Square Bucket 17L	£9.99



CASTING FINGER STALL

- Unique ambidextrous design so will suit both left and right-handed casters
- Soft protective material on finger that is more sensitive than traditional leather finger stalls enabling better 'feel' when casting
- Quick-drying material

		*RRP
CAC572	Casting Finger Stall	£7.99

RANGEMASTER



RANGEMASTER® POWERGUARD® METHOD POUCH

- Curved ergonomic handle for increased comfort and control - curve in handle corrects for, and prevents the need for, wrist flexion when baiting
- Features patented knuckle defender
- Swing Head fixings help to prevent elastic from twisting
- Moulded Method pouch prevents groundbait ball from being crushed when under tension
- Textured rubber grip on pouch
- One-piece monocoque polymer frame
- 'Teardrop' profile on handle to prevent twisting in the hand when in use, which aids accuracy

- Sculptured finger grips for greater comfort and control
- Non-tear material on pouch
- Spare elastics, pouches and elastic connectors available separately

		*RRP
CPT027	Method Pouch Catapult	£15.99
CPT028	Spare Elastic & 2x Connectors	£5.49
CPT030	Spare Method Pouch & 2x Connectors	£7.49



RANGEMASTER® POWERGUARD® MULTI POUCH

- Curved ergonomic handle for increased comfort and control - curve in handle corrects for, and prevents the need for, wrist flexion when baiting
- Features patented knuckle defender
- Swing Head fixings help to prevent elastic from twisting
- Textured rubber grip on pouch
- One-piece monocoque polymer frame
- 'Teardrop' profile on handle to prevent twisting in the hand when in use, which aids accuracy
- Deep conical pouch, for optimum baiting loads and accuracy

- Non-tear material on pouch
- Pouch has non-slip grip for easier use with wet hands
- Multi-purpose pouch that is ideal for a wide variety of baits including boilies, particles and pellets
- Spare pouches and elastic connectors available separately

		*RRP
CPT026	Multi Pouch Catapult	£15.99
CPT028	Spare Elastic & 2x Connectors	£5.49
CPT029	Spare Multi Pouch & 2x Connectors	£7.49



RANGEMASTER® POWERGRIP METHOD POUCH

- Curved ergonomic handle for increased comfort and control - curve in handle corrects for, and prevents the need for, wrist flexion when baiting
- Moulded Method pouch prevents groundbait ball from being crushed when under tension
- Textured rubber grip on pouch
- One-piece monocoque polymer frame
- 'Teardrop' profile on handle to prevent twisting in the hand when in use, which aids accuracy
- Sculptured finger grips for greater comfort and control
- Wide elastic connections for improved elastic flow through frame with reduced tangling
- Non-tear material on pouch

		*RRP
CPT025	Method Pouch Catapult	£13.99



RANGEMASTER® POWERGRIP MULTI POUCH

- Curved ergonomic handle for increased comfort and control - curve in handle corrects for, and prevents the need for, wrist flexion when baiting
- One-piece monocoque polymer frame
- 'Teardrop' profile on handle to prevent twisting in the hand when in use, which aids accuracy
- Sculptured finger grips for greater comfort and control
- Wide elastic connections for improved elastic flow through frame with reduced tangling
- Deep conical pouch, for optimum baiting loads and accuracy
- Non-tear material on pouch
- Pouch has non-slip grip for easier use with wet and cold hands
- Multi-purpose pouch that is ideal for a wide variety of baits including boilies, particles and pellets

		*RRP
CPT024	Multi Pouch Catapult	£13.99

NEW



Boilie Baiting Spoon



Large Baiting Spoon



Particle Baiting Spoon



Mini Baiting Spoon



Distance Baiting Spoon

BAITING SPOONS

- Five models of Bait Spoon now available
- Distance – ideal for use with long handle for baiting at range
- Slots allow liquid drain-off on Distance model
- Large - perfect all-rounder for variety of baits including boilies and pellets
- Mini - ideal for loading Impact Spods and Spombs, loading bait boat hoppers, for mixing up ingredients and controlled baiting when only small quantities are needed
- Boilie – as name suggests perfect for baiting with boilies
- Particle - features slots for liquid drainage making it perfect for use with particles
- Super-strong lightweight moulded design
- Supplied with screw-on knurled aluminium handle that includes hand cord

		*RRP
CTL001	Boilie Baiting Spoon	£15.99
CTL002	Mini Baiting Spoon	£13.99
CTL003	Particle Baiting Spoon	£15.99
CTL004	Large Baiting Spoon	£15.99
CTL005	Distance Baiting Spoon	£11.99



NEW

EDGES® ARMA® MESH SYSTEMS

- Perfect material for creating alternative hookbaits that are normally very tricky to present on a Hair Rig
- Ideal for baits such as bread, sweetcorn, paste, prawns, cheese, mini pellets etc
- Can also be used to protect boilie hookbaits from nuisance species
- Available in Narrow 14mm and Wide 22mm
- Supplied with moulded loading tube and plunger
- 7m of mesh per dispenser

		*RRP
CAC715	Arma Mesh Narrow 14mm x 7mm	£9.99
CAC716	Arma Mesh Narrow 22mm x 7mm	£9.99



IDEAL FOR...



Bread



Sweetcorn



Pellets

HIGH RISERS

- Biodegradable, fish-safe and totally water-soluble foam nuggets
- Designed to give you perfect tangle-free presentation
- The foam keeps your rig suspended from the lakebed for a few seconds before it dissolves leaving your hooklength to sit perfectly over any debris
- Jumbo Refill Pack also available

		*RRP
CAC358	Risers Pop-up Foam	£4.99
CPV042	High Riser Jumbo Refill	£4.25



PVA STRIPS

- Designed for use with Chod/Heli Buffer Sleeve, Heli Buffer Sleeve and Angled Drop Off Run Rig Kit when wanting the lead to eject
- Small PVA strip threading into hole on sleeve and is cut down to size
- Melt time depends on water temperature
- 10 lengths supplied per packet



		*RRP
CPV047	Edges PVA Strips x 10pc	£3.75



NEW



SOLID PVA BAG BENEFITS

- ✓ Rig cannot tangle on cast
- ✓ Rig will be presented effectively over pretty much any lakebed
- ✓ Aerodynamic so can be cast a long way and also very accurately
- ✓ Allows your hookbait to sit right in amongst a highly attractive pile of bait

EDGES® RAPIDE™ LOAD PVA BAG SYSTEM - FAST MELT

- Eliminates the need for PVA tape to tie the solid PVA bag
- Makes tying a solid PVA bag easier than ever before
- Use the unique tool to fill the PVA bag and tie it too
- Two sizes of loading tool available: Large and Small
- Large tool works with 3 different sized PVA bags: 85mm x 140mm, 75 x 175mm and 85mm x 220mm
- Small tool works with 2 sizes of bag: 55mm x 120mm and 60mm x 130mm
- Supplied with Orange loading tool, Black locking collar, 25 Fast Melt PVA bags (20 for 75mm x 175mm and 85mm x 220mm)
- Supplied in a handy plastic moulded tube to keep everything dry and organised
- System available in Fast Melt only
- Fast Melt and Slow Melt Refills available separately



Use the unique tool to fill the PVA bag

		*RRP
CPV048	55mm x 120mm Bags	£8.99
CPV049	60mm x 130mm Bags	£8.99
CPV050	85mm x 140mm Bags	£8.99
CPV051	75mm x 175mm Bags	£8.99
CPV052	85mm x 220mm Bags	£8.99



Makes tying a solid PVA bag easier than ever before

EDGES® RAPIDE™ LOAD PVA BAG REFILLS

- Available in 85mm x 140mm, 75 x 175mm and 85mm x 220mm to fit large loading tool
- Also available in 55mm x 120mm and 60mm x 130mm to fit small loading tool
- Available in Fast Melt for winter use or in shallow water
- Slow Melt options also available for summer use or in deep water
- The Slow Melt bags are increased micron meaning they are thicker and more robust
- Refill bags feature actual sized 2D image on front that represents the perfect size of bag they can make
- 25 bags in 85mm x 140mm, 55mm x 120mm and 60mm x 130mm
- 20 bags in 75mm x 175mm and 85mm x 220mm



		*RRP
CPV053	Fast Melt 55mm x 120mm Refills	£3.25
CPV054	Fast Melt 60mm x 130mm Refills	£3.25
CPV055	Fast Melt 85mm x 140mm Refills	£3.25
CPV056	Fast Melt 75mm x 175mm Refills	£3.25
CPV057	Fast Melt 85mm x 220mm Refills	£3.25



		*RRP
CPV058	Slow Melt 55mm x 120mm Refills	£3.49
CPV059	Slow Melt 60mm x 130mm Refills	£3.49
CPV060	Slow Melt 85mm x 140mm Refills	£3.49
CPV061	Slow Melt 75mm x 175mm Refills	£3.49
CPV062	Slow Melt 85mm x 220mm Refills	£3.49

NEW



EDGES® PVA MESH SYSTEM

- Highest quality anti-ladder PVA mesh
- System comes supplied with 7m of mesh, loading funnel and a moulded plunger
- Three sizes available: Stix 14mm, Narrow 25mm and Wide 35mm
- Available in Fast Melt for winter use or in shallow water
- Slow Melt options also available for summer use or in deep water
- Supplied in a handy plastic moulded tube to keep everything dry and organised

			*RRP
CPV063	PVA Mesh 7m Fast Melt 35mm Wide	£9.99	
CPV064	PVA Mesh 7m Fast Melt 25mm Narrow	£9.99	
CPV065	PVA Mesh 7m Fast Melt 14mm Stix	£9.99	
CPV072	PVA Mesh 7m Slow Melt 35mm Wide	£9.99	
CPV073	PVA Mesh 7m Slow Melt 25mm Narrow	£9.99	
CPV074	PVA Mesh 7m Slow Melt 14mm Stix	£9.99	

EDGES® PVA TAPE

- Dissolvable tape that is perfect for a host of applications such as creating PVA stringers and tying off solid PVA bags
- Available in Fast Melt for winter use or in shallow water
- Slow Melt options also available for summer use or in deep water
- 20m of tape on Slow Melt, 40m of tape on Fast Melt



			*RRP
CPV081	PVA Tape Slow Melt 10mm x 20m	£3.99	
CPV082	PVA Tape Fast Melt 5mm x 40m	£3.99	



EDGES® PVA MESH REFILLS

- Highest quality anti-ladder PVA mesh
- Designed for refilling your Edges PVA Mesh System
- Three sizes available: Stix 14mm, Narrow 25mm and Wide 35mm
- Available in Fast Melt for winter use or in shallow water
- Slow Melt options also available for summer use or in deep water
- Available in two length options: 5m and 20m

			*RRP
CPV066	5m Fast Refill 35mm Wide	£4.99	
CPV067	5m Fast Refill 25mm Narrow	£4.99	
CPV068	5m Fast Refill 14mm Stix	£4.99	
CPV069	20m Fast Refill 35mm Wide	£18.99	
CPV070	20m Fast Refill 25mm Narrow	£18.99	
CPV071	20m Fast Refill 14mm Stix	£18.99	



			*RRP
CPV075	5m Slow Refill 35mm Wide	£5.99	
CPV076	5m Slow Refill 25mm Narrow	£5.99	
CPV077	5m Slow Refill 14mm Stix	£5.99	
CPV078	20m Slow Refill 35mm Wide	£18.99	
CPV079	20m Slow Refill 25mm Narrow	£18.99	
CPV080	20m Slow Refill 14mm Stix	£18.99	

SPOMB™



THE SPOMB™ LARGE

- Patented design allows content of Spomb to be released instantly upon impact with the water's surface
- Eliminates 'spod spill' - once loaded and shut you will lose no bait on the cast
- Aerodynamic design allows for accurate baiting at range even in strong winds
- Fast and easy retrieve with the opened Spomb gliding effortlessly across the top of the water with little to no resistance
- Perfect for baiting with large quantities very quickly

- The design is very versatile as it can be used with all manner of different baits including pellets, boilies, hemp, groundbait balls, corn, dog biscuits, maggots, meat, bread and particles
- Designed for use with purpose-made spod/Spomb rods
- Available in both Black and White

		*RRP
CSM001	Large Spomb Black	£13.99
CSM002	Large Spomb White	£13.99

THE SPOMB™ MIDI

- A smaller version of the original Large Spomb that can be cast with normal fishing rods of a lower test curve than that of a spod rod
- Patented design allows content of Spomb to be released instantly upon impact with the water's surface
- Eliminates 'spod spill' - once loaded and shut you will lose no bait on the cast
- Aerodynamic design allows for accurate baiting at range even in strong winds
- Fast and easy retrieve with the opened Spomb gliding effortlessly across the top of the water with little to no resistance

- The design is very versatile as it can be used with all manner of different baits including pellets, boilies, hemp, groundbait balls, corn, dog biscuits, maggots, meat, bread and particles
- Ideal for baiting at extreme range, for feeding on a little and often basis or use on a lighter test curve rod than that of a conventional spod rod
- Available in both Black and White

		*RRP
CSM003	Midi Spomb Black	£12.99
CSM004	Midi Spomb White	£12.99

THE SPOMB™ MINI

- This model complies with various fishing competition rules across the globe that often state that a baiting product cannot exceed 50mm in diameter or are restricted in length
- Can be cast with any rod - maximum weight when fully loaded is 3oz (85g)
- Ideal for baiting with a minimal amount of feed
- Keeps disturbance to a minimum
- Patented design allows content of Spomb to be released instantly upon impact with the water's surface
- Eliminates 'spod spill' - once loaded and shut you will lose no bait on the cast

- Aerodynamic design allows for accurate baiting at range even in strong winds
- Fast and easy retrieve with the opened Spomb gliding effortlessly across the top of the water with little to no resistance
- The design is very versatile as it can be used with all manner of different baits including pellets, boilies, hemp, corn, dog biscuits, maggots, meat, bread and particles
- Available in both Black and White

		*RRP
CSM005	Mini Spomb Black	£10.99
CSM006	Mini Spomb White	£10.99

FEATURES



Patented design allows instant release upon impact with the water surface



Aerodynamic design for accurate baiting



Can be used with a variety of baits



Spomb floats thread onto the rear of the Spomb to prevent sinking



THE SPOMB™ FLOATS

- Designed to thread onto rear of Spomb
- Prevents Spomb from sinking, so they can be retrieved if your line breaks
- Streamlined design to ensure minimal reduction on maximum casting distance
- Two per packet - 1x Red and 1x White/Black

		*RRP
CSM007	Spomb Floats x2	£1.49



CLOTHING

It never ceases to amaze us just how much demand there is for dedicated fishing clothing. With every year that passes, our clothing design team find themselves busier and busier as they work on expanding our range to suit the many and varied needs of our customers.

Within the Fox clothing portfolio you'll find three distinct ranges. Firstly, Fox Chunk, which blends high street fashion with outdoor performance. Then we have our Orange & Black, and Green & Black ranges. All three utilise top-quality materials and have been designed by anglers. You can be safe in the knowledge therefore, that they'll 'do the do'!

We have a number of new additions for 2019, including T-shirts, hoodies, joggers, waterproofs, footwear and headwear. We believe our portfolio is well constructed and that it constitutes the most comprehensive, stylish and practical on the market today. We hope when you see it, that you'll all agree!

NEW



FOX® Chunk

FOX® CHUNK CAMO LIGHTWEIGHT WADERS

- Constructed from durable Nylon Taslon fabric
- Lightweight fabric makes them ideal for use in warmer months
- Perfect for anglers who spend a lot of time fishing in their waders
- Fully-taped seams
- Styled in unique Fox Camo print
- Heavy duty PVC boots with textured soles that give good grip
- Adjustable, elasticated braces that feature quick-release buckles
- Chest drawcord for comfortable fit
- Inner chest pocket for storing essentials
- Available in sizes 7(41)-12(46)

*RRP

Foot Sizes available: 7(41)-12(46)

£64.99

FEATURES



Textured soles for good grip



Adjustable, elasticated braces with quick-release buckles

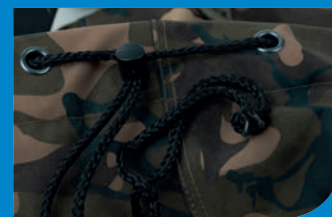

Chest drawcord for comfortable fit

FOX® CHEST WADERS

- 700g heavy-duty fabric
- Chunky soles for maximum grip
- Fox-branded fully adjustable elasticated shoulder straps
- Adjustable elasticated chest
- Reinforced knee sections for added protection
- Perfect for anglers that need to enter the margins for landing fish, placing rigs, baiting up, catch pictures and returning fish safely

*RRP

Foot Sizes available: 7(41)-12(46)

£79.99



FEATURES



Chunky sole for maximum grip



Adjustable elasticated chest

FOX® WINTER SUIT

- Top-quality thermal insulation on both garments to keep you warm in the coldest months
- Jacket and salopettes both have PU coating with hydrostatic head of 5000mm
- Both jacket and salopettes are 3000gsm/24hr breathable
- Two-way main zip (with baffles) on both jacket and salopettes
- Jacket features micro-fleece lining on pockets, collar and hood
- Hood on jacket is removable and also features high chin baffle with adjustable bungee cords
- Adjustable bungee cord hem on jacket
- Jacket also features internal zipped chest pocket, neoprene inner snug cuffs with thumb holes and Fox branding
- Salopettes feature Fox-branded elasticated shoulder straps with quick-release buckles as well as elasticated waist panels
- Micro-fleece lining from knee upwards on salopettes, whilst the knee section is also pleated
- Salopettes have boot zips and adjustable ankle straps with Fox-branded rubber pull tabs
- Sizes available: S/M/L/XL/XXL/XXXL
- Outer – 100% Nylon
Thermal Insulation – 100% Polyester
Lining – 100% Polyester



*RRP

Sizes available: S/M/L/XL/XXL/XXXL

£149.99

FOX® CHUNK OLIVE QUILTED JACKET

- Quilted lightweight hooded jacket
- Special blend of synthetic fibres give an insulated and comfortable filling
- PU water-resistant coated outer fabric
- Zipped hand pockets
- Full length zip baffle
- Internal pocket
- Sizes available: S/M/L/XL/XXL/XXXL
- Outer: 100% Nylon, Padding: 100% Polyester, Lining: 100% Nylon



*RRP

Sizes available: S/M/L/XL/XXL/XXXL

£54.99

FEATURES



Neoprene snug cuffs with Velcro fastening on jacket to prevent draughts

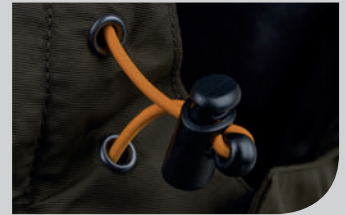

Adjustable bungee cords on jacket hood to help keep the cold out



High collar with micro-fleece lining, full length zip and baffles to maximise heat retention

FEATURES



The Quilted Jacket benefits from a special blend of fibres that keep you warm and comfortable

FOX® Chunk

FOX® CHUNK 10K HYDRO JACKET

- Our most advanced and technical waterproof clothing ever!
- 3/4 length jacket that uses a three-layer construction
- DWR waterproof outer layer with a breathable hydro performance membrane mid layer
- All internal seams are fully taped to prevent water ingress
- 10,000mm Hydrostatic Head
- 3000g/m² breathable
- YKK waterproof front zip with internal storm flap and chin guard
- Waterproof YKK zips throughout
- Fully-adjustable wired peak hood
- Brush-lined integral collar
- Double-exit hem drawcord
- Velcro adjustable outer cuffs
- Neoprene snug cuffs
- Lumbar drawcord
- Styled in unique Fox Camo pattern
- Sizes available: S/M/L/XL/XXL/XXXL



*RRP

Sizes available: S/M/L/XL/XXL/XXXL

£159.99

FOX® CHUNK 10K HYDRO SALOPETTES

- Our most advanced and technical waterproof clothing ever!
- As with the Jacket these Salopettes also use a three-layer construction
- DWR waterproof outer layer with a breathable hydro performance membrane mid layer
- All internal seams are fully taped to prevent water ingress
- 10,000mm Hydrostatic Head
- 3000g/m² breathable
- Three layer construction
- YKK waterproof front zip with internal storm flap
- Waterproof YKK zips throughout
- Khaki colour
- Velcro adjustable ankle cuffs
- Velcro fastening cargo pockets
- Half-leg waterproof YKK zips with internal storm guard
- Tricot-lined hand-warmer pockets
- Part-elasticated waist
- Padded pleated knees
- Adjustable branded shoulder straps
- Sizes available: S/M/L/XL/XXL/XXXL



*RRP

Sizes available: S/M/L/XL/XXL/XXXL

£134.99

FEATURES



Three-layer construction to ensure market-leading performance



Adjustable Velcro cuffs help to keep water out



All internal seams are fully taped to prevent water penetration

FEATURES



Half-leg waterproof YKK zips with Velcro storm guards



All internal seams are fully taped to prevent water ingress

NEW



FOX® CHUNK LIGHTWEIGHT CAMO RS 10K JACKET

- Unique Fox Camo print polyester Rip Stop fabric
- 10,000 water-resistant hydrostatic head
- 3000g/m2 breathable
- Taped seams
- Lightweight three layer construction
- Waterproof zips
- Zipped storage pockets
- Adjustable elasticated cuffs
- Adjustable drawcord hem
- Packs away inside own pocket for compact storage
- Sizes available: S/M/L/XL/XXL/XXXL
- 100% polyester

*RRP

Sizes available: S/M/L/XL/XXL/XXXL

£79.99



FOX® CHUNK LIGHTWEIGHT CAMO RS 10K TROUSERS

- Unique Fox Camo print polyester Rip Stop fabric
- 10,000 water resistant hydrostatic head
- 3000g/m2 breathable
- Taped seams
- Lightweight 3 layer construction
- Waterproof zips
- Zipped storage pockets
- Boot access ankle zips and gusset
- Packs away inside own pocket for compact storage
- Sizes available: S/M/L/XL/XXL/XXXL
- 100% polyester

*RRP

Sizes available: S/M/L/XL/XXL/XXXL

£59.99



Both pack away
inside own pocket



FEATURES



Waterproof zips



Drawcord hood



Adjustable elasticated cuffs

FEATURES



Elasticated drawcord waist for snug fit



Ankle zips for boot access



FOX® CHUNK CAMO SOFTSHELL HOODY

- Shower and wind-resistant soft shell hoody styled in unique Fox Camo
- 8000mm hydro static head and 2000Gsm/24hr breathable
- Drawstring hood
- Elasticated cuffs and waist
- External zipped chest pocket
- Pouch pockets
- Full length front zip
- Outer: 96% Polyester, 4% Elastane, Lining: 100% Polyester

*RRP

Sizes available: S/M/L/XL/XXL/XXXL

£59.99

NEW



FOX® CHUNK CAMO FUNNEL NECK HOODY

- Funnel neck hood design
- Kangaroo pocket
- Concealed pocket with press stud fastener
- Unique Fox Camo print design
- 80% Cotton, 20% Polyester

*RRP

Sizes available: S/M/L/XL/XXL/XXXL

£49.99

FOX® Chunk



FOX® CHUNK CAMO JOGGER SHORTS

- Features unique Fox Camo pattern
- Elasticated, drawcord waist
- Main fabric: 80% Cotton, 20% Polyester
- Sizes available: S/M/L/XL/XXL/XXXL

*RRP

Sizes available: S/M/L/XL/XXL/XXXL

£19.99



FOX® CHUNK CAMO HOODY

- Feature unique Fox Camo pattern
- Fully lined with a soft, insulating tricot fabric
- Lined hand-warming kangaroo front pocket
- Elasticated cuffs
- Drawcords on hood
- Branded metal eyelets
- Soft brushed back fabric
- Main fabric: 80% cotton 20% polyester
Lining: 100% cotton
- Matching joggers available

*RRP

Sizes available: S/M/L/XL/XXL/XXXL

£54.99



FOX® CHUNK CAMO JOGGERS

- Feature unique Fox Camo pattern
- Fully lined with a soft, insulating tricot fabric
- Zipped front pockets
- Elasticated ankles and waist
- Drawcord on waist
- Branded metal eyelets
- Soft brushed back fabric
- Main fabric: 80% cotton 20% polyester
Lining: 100% cotton
- Matching hoody available

*RRP

Sizes available: S/M/L/XL/XXL/XXXL

£44.99



FOX® CHUNK LIGHTWEIGHT CARGO SHORTS

- Fox Camo pattern
- Lightweight cargo pant style
- Perfect for summer use
- Button, zip and belt loops on waist
- Two front pockets
- Two 'button up' side pockets
- Two rear pockets
- Main fabric: 100% cotton

*RRP

Sizes available: S/M/L/XL/XXL/XXXL

£26.99

NEW



**FOX® CHUNK
CAMO/DARK KHAKI
TRACK HOODY**

- Track-style full zip hoody
- Features unique Fox Camo print
- Contrasting Khaki panels
- 100% Polyester
- Sizes available: S/M/L/XL/XXL/XXXL

Sizes available: S/M/L/XL/XXL/XXXL ***RRP**
£49.99



**FOX® CHUNK
CAMO/DARK KHAKI
PULLOVER HOODY**

- Pullover raglan-style hoody with a high, elasticated neck front panel
- Constructed using a blend of polyester and cotton for comfort and style
- Unique Fox Camo print on hood lining
- Kangaroo pocket with Fox Camo trim
- 65% Polyester, 35% Cotton
- Sizes available: S/M/L/XL/XXL/XXXL

Sizes available: S/M/L/XL/XXL/XXXL ***RRP**
£44.99



**FOX® CHUNK
CAMO/DARK KHAKI
JOGGERS**

- Fitted joggers with tapered leg
- Constructed using a blend of polyester and cotton for comfort and style
- Zipped front pockets
- Fox Camo trim on pocket
- Rear pocket
- 65% Polyester, 35% Cotton
- Sizes available: S/M/L/XL/XXL/XXXL

Sizes available: S/M/L/XL/XXL/XXXL ***RRP**
£34.99



**FOX® CHUNK
CAMO/DARK KHAKI
LONG SLEEVE T-SHIRT**

- ¼ length zip
- Dark Khaki body with contrasting Fox Camo print sleeves
- Ribbed wrist cuffs
- Fox Camo Edition branding
- 100% Cotton
- Sizes available: S/M/L/XL/XXL/XXXL

Sizes available: S/M/L/XL/XXL/XXXL ***RRP**
£19.99



**FOX® CHUNK
CAMO/DARK KHAKI
T SHIRT**

- Fox Camo print on body section
- Dark khaki coloured sleeves
- Fox Camo Edition branding
- 100% Cotton
- Sizes available: S/M/L/XL/XXL/XXXL

Sizes available: S/M/L/XL/XXL/XXXL ***RRP**
£16.99



**FOX® CHUNK
THERMOLITE® SOCKS**

- Thermolite® insulation for added warmth and durability
- Quick drying moisture repellent
- Two sizes available: 6-9 (EU 40-43) and 10-13 (EU 44-47)
- 82% Thermolite®, 14% Lycra®, 4% Nylon

Sizes available: 6-9(40-43), 10-13(44-47) ***RRP**
£9.99

NEW



**FOX® CHUNK
DARK OLIVE HOODY**

- 1/4 zip pullover hoody
- Fox Camo print on hood lining
- Constructed using a blend of polyester and cotton for comfort and style
- Kangaroo pocket
- Sport mesh breathable fabric
- 65% Polyester, 35% Cotton
- Sizes available: S/M/L/XL/XXL/XXXL

Sizes available: S/M/L/XL/XXL/XXXL *RRP
£44.99



**FOX® CHUNK
DARK OLIVE JOGGERS**

- Fitted joggers with tapered leg
- Constructed using a blend of polyester and cotton for comfort and style
- Zipped front pockets
- Fox Camo lining on pockets
- Rear pocket
- Sport mesh breathable fabric
- 65% Polyester, 35% Cotton
- Sizes available: S/M/L/XL/XXL/XXXL

Sizes available: S/M/L/XL/XXL/XXXL *RRP
£34.99



**FOX® CHUNK
KHAKI COMBAT TROUSERS**

- Tailored fit with a semi-elasticated waist for added comfort
- Oil washed giving a softer feel fabric
- Waist features belt loops
- Utility pockets for storing essential items
- Sizes available: S/M/L/XL/XXL/XXXL
- Main fabric: 100% Cotton

Sizes available: S/M/L/XL/XXL/XXXL *RRP
£39.99



**FOX® CHUNK
DARK KHAKI CLASSIC T-SHIRT**

- Dark khaki colour
- Subtle Fox Chunk Classic Collection branding
- 100% Cotton
- Sizes available: S/M/L/XL/XXL/XXXL

Sizes available: S/M/L/XL/XXL/XXXL *RRP
£15.99



**FOX® CHUNK
DARK KHAKI SCENIC T-SHIRT**

- Unique 'carpy' monotone scenic print
- 100% Cotton
- Sizes available: S/M/L/XL/XXL/XXXL

Sizes available: S/M/L/XL/XXL/XXXL *RRP
£15.99

NEW



**FOX® CHUNK
HEATHER CLASSIC T-SHIRT**

- Heather Marl
- Subtle Fox Chunk Classic Collection branding
- 60% Cotton 40% Polyester
- Sizes available: S/M/L/XL/XXL/XXXL

Sizes available: S/M/L/XL/XXL/XXXL *RRP
£15.99

FOX
Chunk



**FOX® CHUNK
CAMO SUNGLASSES**

- Camo frame
- Polarized TAC impact-resistant lens
- Brown lens
- UV400 Protection
- Supplied with hard case and cleaning cloth



**FOX® CHUNK
KHAKI SUNGLASSES**

- Khaki frame
- Polarized TAC impact-resistant lens
- Grey lens
- UV400 protection
- Supplied with hard case and cleaning cloth



**FOX® CHUNK
TORTOISE SHELL SUNGLASSES**

- Tortoise shell frame
- Polarized TAC impact-resistant lens
- Brown lens
- UV400 protection
- Supplied with hard case and cleaning cloth



FOX® SUNGLASSES

- Black frame with orange rubber inlay
- Polarized TAC impact-resistant lens
- Grey lens
- UV400 Protection
- Supplied with hard case and cleaning cloth

	*RRP
Camo Sunglasses	£19.99
Khaki Sunglasses	£19.99
Tortoise Shell Sunglasses	£19.99
Fox Sunglasses	£16.99



FOX®
Chunk



FOX® CHUNK CAMO FLIP FLOPS

- Fox Camo strap
- Neoprene lining on strap for added comfort
- Fox Camo print EVA footbed
- Durable rubber outer sole
- Tread on sole provides good grip
- Strap: 100% Polyester / Lining: 100% Neoprene, Footbed: 100% EVA, Outsole: 100% Rubber

*RRP

Sizes available: 7(41)-12(46)

£24.99



FOX® CHUNK CAMO CLOGS

- One piece moulded top, footbed and sole
- Fox Camo print
- Waterproof and buoyant
- Lightweight
- Easy to clean and quick drying
- Heel strap for secure fit
- Easy to slip on and off
- Ventilation ports encourage water to drain away and air circulation
- 100% EVA
- Available in sizes: 7(41), 8(42), 9(43), 10(44), 11(45) and 12(46)

*RRP

Sizes available: 7(41)-12(46)

£15.99



FOX® CHUNK CAMO FLEECE CLOGS

- Features unique Fox Camo print
- Removable fleece lining sock for keeping your warm in cooler temperatures
- Sizes available: 7(41), 8(42), 9(43), 10(44), 11(45) and 12(46)
- Lining: 100% polyester

*RRP

Sizes available: 7(41)-12(46)

£17.99

NEW



FOX® CHUNK MESH TRAINERS

- Breathable, mesh fabric upper section
- Mesh section allows for quick-drying and also prevents feet from sweating in hot conditions
- Hard-wearing, through flow rubber sole
- Sizes available: 7(41), 8(42), 9(43), 10(44), 11(45) and 12(46)

*RRP

Sizes available: 7(41)-12(46)

£34.99



FOX® CHUNK KHAKI SHOES

- Fold & Fix tongue
- Waterproof membrane
- Mesh lining, breathable for extra comfort
- Heel guard for durability and protection
- EVA Phylon sole cushioning for added comfort
- Rugged rubber outsole with Dynagrip tread for extra grip and traction
- Durable upper materials designed for outdoor use
- Sizes available 7(41), 8(42), 9(43), 10(44), 11(45) and 12(46)

*RRP

Sizes available: 7(41)-12(46)

£59.99



FOX® CHUNK KHAKI MID BOOTS

- Fold & Fix tongue
- Waterproof membrane
- Mesh lining, breathable for extra comfort
- EVA Phylon sole cushioning for added comfort
- Rugged rubber outsole with Dynagrip tread for extra grip and traction
- Durable upper materials designed for outdoor use
- Sizes available: 7(41), 8(42), 9(43), 10(44), 11(45) and 12(46)

*RRP

Sizes available: 7(41)-12(46)

£59.99



BOBBLE HAT

■ Main fabric: 100% Acrylic

CPR763 Burgundy/Black Bobble

CPR762 Grey/Black Bobble



BEANIE

■ Main fabric: 50% Acrylic, 50% Polyester

CPR759 Orange/Black Marl Beanie

CPR760 Grey/Black Marl Beanie

CPR761 Burgundy/Black Marl Beanie



HEAVY KNIT HAT

■ Main fabric: 100% Acrylic

CPR764 Camo Heavy Knit Beanie



PEAKED BEANIE

■ Main fabric: 100% Acrylic

CPR766 Grey Peaked Beanie

NEW



LINED BOBBLE HAT

■ Outer: 100% Acrylic, Lining: 100% Polyester

CPR990 Green / Silver Lined Bobble

CPR991 Black / Orange Lined Bobble

BEANIE

■ Outer: 100% Acrylic, Lining: 100% Polyester

CPR992 Green / Silver Beanie

CPR993 Black / Orange Beanie



NEW



CAMO TRUCKER CAP

- Features unique Fox Camo print
- Black mesh panels
- Main fabric: 100% Polyester

CPR982 Camo Trucker Cap



CAMO SNAPBACK CAP

- Features unique Fox Camo print
- Flat peak design
- Main fabric: 100% Polyester

CPR981 Camo Snapback Cap



CAMO SNOOD

- Can be worn in three different ways: as a cap, balaclava or scarf
- Provides added warmth
- Unique Fox camo print
- 100% Polyester

CPR994 Camo Snood



GREEN/BLACK TRUCKER CAP

- Complements Fox Green & Black clothing range
- Main fabric: 65% Cotton, 35% Polyester

CPR926 Green / Black Trucker Cap



GREEN/BLACK BASEBALL CAP

- Complements Fox Green & Black clothing range
- Main fabric: 100% Cotton

CPR927 Green / Black Baseball Cap



BLACK/ORANGE TRUCKER CAP

- Complements Fox Orange & Black clothing range
- Main fabric: 65% Cotton, 35% Polyester

CPR924 Black / Orange Trucker Cap



BLACK/ORANGE BASEBALL CAP

- Complements Fox Orange & Black clothing range
- Main fabric: 100% Cotton

CPR925 Black / Orange Baseball Cap



BLACK/CAMO LINING SNAPBACK CAP

- Features Fox International logo
- Outer: 100% Acrylic wool, Lining: 100% Polyester

CPR983 Black Snapback



BLACK & ORANGE LIGHTWEIGHT ZIPPED HOODY

- Drawcord hood
- Elasticated cuffs and hem
- Orange Fox logo
- Main fabric: 50% cotton, 50% polyester
- Sizes available: S/M/L/XL/XXL/XXXL

*RRP

Sizes available: S/M/L/XL/XXL/XXXL

£24.99



BLACK & ORANGE HOODY

- Drawstring hood
- Elasticated waist and cuffs
- Centre pocket
- Main fabric: 20% Polyester, 80% Cotton

*RRP

Sizes available: S/M/L/XL/XXL/XXXL

£39.99



BLACK & ORANGE HEAVY LINED HOODY

- Internal lining for added warmth
- Easy-slide zip
- Drawstring hood
- Elasticated waist
- Centre pocket
- Main fabric: 20% Polyester, 80% Cotton
Lining: 100% Polyester

*RRP

Sizes available: S/M/L/XL/XXL/XXXL

£49.99



BLACK & ORANGE SOFT SHELL HOODY

- Full-length front zip
- Phone pocket
- Elasticated waist
- Elasticated cuffs
- Drawstring hood
- Main fabric: 96% Polyester, 4% Elastane
Lining: 100% Polyester

*RRP

Sizes available: S/M/L/XL/XXL/XXXL

£59.99



BLACK & ORANGE SOFT SHELL JACKET

- Full-length front zip
- Phone pocket
- Drawstring waist
- Zip pockets
- Elasticated and Velcro cuffs
- Drawstring hood
- Main fabric: 96% Polyester, 4% Elastane
Lining: 100% Polyester

*RRP

Sizes available: S/M/L/XL/XXL/XXXL

£69.99



BLACK & ORANGE POLO SHIRT

- Orange trim to sleeves
- Button-up collar
- Fox logo on chest
- Main fabric: 20% Polyester, 80% Cotton

*RRP

Sizes available: S/M/L/XL/XXL/XXXL

£19.99



BLACK & ORANGE T-SHIRT

- Orange trim to sleeves
- Fox logo on chest
- Main fabric: 100% Cotton

*RRP

Sizes available: S/M/L/XL/XXL/XXXL

£17.99



BLACK & ORANGE LIGHTWEIGHT JOGGER SHORTS

- Drawcord waist
- Orange Fox logo
- Main fabric: 50% cotton, 50% polyester
- Sizes available: S/M/L/XL/XXL/XXXL

*RRP

Sizes available: S/M/L/XL/XXL/XXXL

£16.99



BLACK & ORANGE JOGGERS

- Internal lining for added warmth
- Elasticated waist with drawcord
- Zipped pockets
- Elasticated ankles
- Main fabric: 20% Polyester, 80% Cotton
Lining: 100% Polyester

*RRP

Sizes available: S/M/L/XL/XXL/XXXL

£37.99



BLACK & ORANGE HEAVY LINED JOGGERS

- Internal lining for added warmth
- Elasticated waist with drawcord
- Zipped pockets
- Elasticated ankles
- Main fabric: 20% Polyester, 80% Cotton
Lining: 100% Polyester

*RRP

Sizes available: S/M/L/XL/XXL/XXXL

£39.99



BLACK & ORANGE LIGHTWEIGHT JOGGERS

- Drawcord waist
- Elasticated ankles
- Orange Fox logo
- Main fabric: 50% cotton, 50% polyester
- Sizes available: S/M/L/XL/XXL/XXXL

*RRP

Sizes available: S/M/L/XL/XXL/XXXL

£24.99



GREEN & BLACK T-SHIRT

- Black trim to sleeves
- Fox logo on chest
- Main fabric: 100% Cotton
- Sizes available: S/M/L/XL/XXL/XXXL

*RRP

Sizes available: S/M/L/XL/XXL/XXXL

£17.99



GREEN & BLACK SOFT SHELL JACKET

- Full-length front zip
- Phone pocket
- Drawstring waist
- Zip pockets
- Elasticated and Velcro cuffs
- Drawstring hood
- Main fabric: 96% Polyester, 4% Elastane
Lining: 100% Polyester
- Sizes available: S/M/L/XL/XXL/XXXL

*RRP

Sizes available: S/M/L/XL/XXL/XXXL

£69.99

FEATURES



Elasticated drawstring hood



High collar with subtle branding



Phone pocket on chest



GREEN & BLACK HOODY

- Drawstring hood
- Elasticated waist and cuffs
- Centre pocket
- Main fabric: 20% Polyester, 80% Cotton
- Sizes available: S/M/L/XL/XXL/XXXL

*RRP

Sizes available: S/M/L/XL/XXL/XXXL

£39.99



GREEN & BLACK HEAVY LINED HOODY

- Internal lining for added warmth
- Easy-slide zip
- Drawstring hood
- Elasticated waist
- Centre pocket
- Main fabric: 20% Polyester, 80% Cotton
Lining: 100% Polyester
- Sizes available: S/M/L/XL/XXL/XXXL

*RRP

Sizes available: S/M/L/XL/XXL/XXXL

£49.99



GREEN & BLACK JOGGER SHORTS

- Main fabric: 50% Polyester, 50% Cotton
- Sizes available: S/M/L/XL/XXL/XXXL

*RRP

Sizes available: S/M/L/XL/XXL/XXXL

£16.99

NEW



GREEN & BLACK JOGGERS

- Elasticated waist with drawcord
- Zipped pockets
- Elasticated ankles
- Main fabric: 20% Polyester, 80% Cotton
- Sizes available: S/M/L/XL/XXL/XXXL

Sizes available: S/M/L/XL/XXL/XXXL

*RRP

£37.99



GREEN & BLACK LIGHTWEIGHT COMBATS

- Lightweight fabric ideal for spring and summer use
- Discreet Fox branding
- Loops on waist for use with belt
- Rear pockets for additional storage
- Leg pockets with studded flap closure for secure storage
- Metal zipped fly
- 100% Cotton
- Sizes available: S/M/L/XL/XXL/XXXL

Sizes available: S/M/L/XL/XXL/XXXL

*RRP

£29.99

FEATURES



Rear pockets for additional storage



Loops on waistband for use with belt



Leg pockets with studded flap closure



UK Headquarters

1 Myrtle Road, Brentwood, Essex, CM14 5EG.

European Distribution Centre

Transportzone Meer, Riyadhstraat 39, 2321 Meer, Belgium.

Fox International reserve the right to modify or alter prices or specifications in any respect without prior notice. Technical data and specification correct at time of going to press. All weights and dimensions are approximate. E. & O.E. Copyright reserved.

Acknowledgements

Live Photography:
Lewis Porter, Mauro Pitorri, Benjamin Versemann,
Hugo Van Gelder, Marian Sura, Andreas Scherf,
Harry Charrington, Bradley Walker, Stefan Fiedel

Translations by:
French: Stefan Hanff
Dutch: Mark Noorman, Roelof Schut
German: Bastian Reetz
Italian: Daniele Pellacani
Polish: Cezary Karolczak
Hungarian: Csaba Balasi
Czech: Jakub Prudík, Roman Vesely
Russian: Alexander Ostapenko, Vladislav Vershinin
Romanian: Andrei Popescu, Robert Nicola

Sub-editor:
Mark Brewster





JOIN TODAY!

Would you like access to a whole host of exclusive content and benefits, including a members-only area of our website and entry to exclusive competitions?

If the answer is 'yes' then make sure you sign up for **The Syndicate** today - it's totally FREE!

Visit www.foxint.com for more details.

Currently only available in English, German, Dutch and French languages.



DOWNLOAD FREE TODAY!

Swim Mapper is designed to help you fish more accurately and effectively than ever before!

It was the world's first App specifically designed to aid anglers when mapping out and logging the details of each swim they fish on any given lake, river or canal.

Using a series of photos and icons, **Swim Mapper** allows you to record specific visual marks and concise distances ensuring you arrive back at a swim you've previously 'mapped' and be angling with pinpoint accuracy within minutes.

To find out more about **Swim Mapper** visit www.swimmapper.com

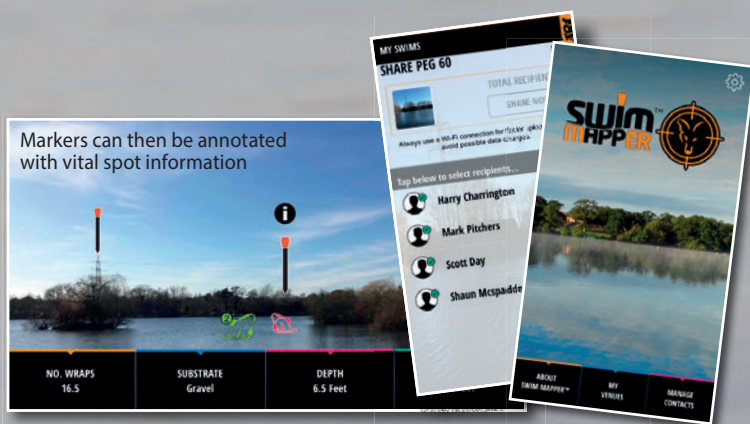

Markers can then be annotated with vital spot information

